

CENTER® 370

RTD THERMOMETER

CE



Instruction Manual

CONTENTS

<i>TITLE</i>	<i>PAGE</i>
1. Introduction	1
2. Specifications	1
3. Symbol Definition and Button Location	3
4. Operation Instructions	5
4.1 Power-Up.....	5
4.2 Connection the Temperature Scale.....	5
4.3 Selecting the Temperature Scale.....	5
4.4 Data-Hold Operation.....	5
4.5 Back light Operation.....	5
4.6 Relative Operation.....	6
4.7 MAX/MIN/AVG Operation.....	6
4.8 Auto Power Off.....	6
4.9 Low Battery Condition.....	7
5. Temperature Measurement	7
6. Temperature Meter Calibration Setup	8
7. Maintenance	13
Replacing the Batteries.....	13
Cleaning.....	14
8. Temperature Probe	15

1. Introduction:

This instrument is a digital thermometer for use with platinum-type temperature sensor.

Temperature indication follows IEC751 temperature table for PT-type sensor.

2. Specifications:

Numerical Display: 4 digital liquid crystal display

Measurement Range: -100°C ~ 300°C; -148°F ~ 572°F

Resolution: 0.1°C; 0.1°F;

Sensor types:

Platinum resistance temperature sensor for pt-100, pt-500, pt-1000 (selectable) 4 wires.

ALPHA=0.003850

Measurement current: Approx 0.53mA

Maximum Voltage at Temperature couple Input:

60V DC, or 24Vrms AC

Environmental:

- o Operating Temperature and Humidity:
0°C ~50°C (32°F ~ 122°F) ; 0 ~ 80% RH
- o Storage Temperature and Humidity:
-10°C to 60°C (14°F ~ 140°F); 0 ~ 80% RH
- o Altitude up to 2000 meters.

Accuracy: at (23 ± 5°C)

Range	Accuracy
-100°C ~ 300°C	±(0.1% reading + 0.4°C)
-148°F ~ 572°F	±(0.1% reading + 0.8°F)

Temperature Coefficient:

For ambient temperatures from 0°C ~ 18°C and 28°C ~ 50°C, for each °C ambient below 18°C or above 28°C add the following tolerance into the accuracy spec.

0.01% of reading + 0.03°C (0.01% of reading + 0.06°F)

Note:

The basic accuracy Specification does not include the error of the probe please refer to the probe accuracy specification for additional details.

Sample Rate: 2 times per second

Water resistance: IP67

Dimension: 150 × 66 × 31mm

Weight: 175g Approx.

Accessory: Pt-100 Probe(class A), Battery, Instruction Menu



Option: Connection Cable

Power requirement: Battery 1.5V X 3 size AAA

Battery Life: Approx. 100hours with alkaline battery

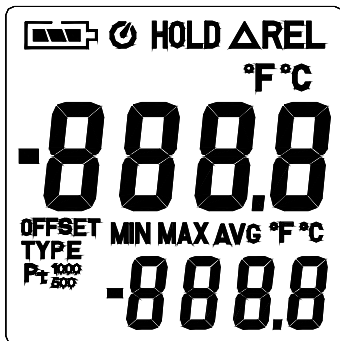
3. Symbol Definition and Button Location:



-	: This indicates that the minus temperature is sensed.
°C °F	: Centigrade and Fahrenheit indication.
Pt xxx	: Platinum Type Indication
HOLD	: This indicates that the display data is being hold.
MAX	: The Maximum value is now being displayed
MIN	: The Minimum value is now being displayed
AVG	: The Average value is now being displayed.
Δ REL	: The reading is now under Relative Mode.
	: The Battery power potential indication.
	: This indicates Auto Power Off is enabled.

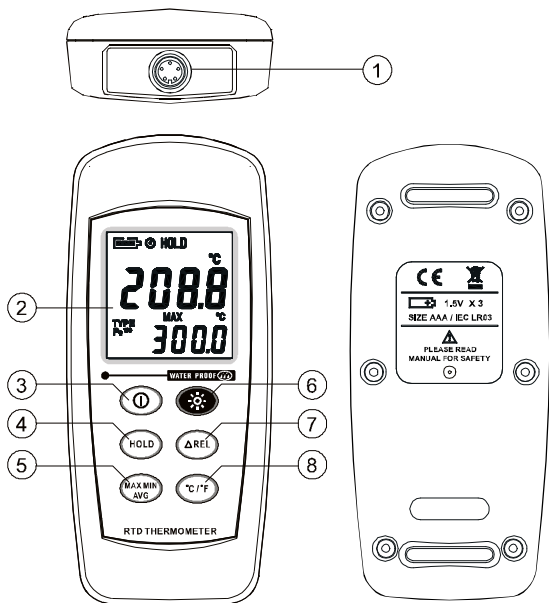

- ❶ Pt type temperature sensor connector
- ❷ LCD display
- ❸ Power ON/OFF button
- ❹ HOLD button
- ❺ MAX MIN Average control button
- ❻ Back light button

- ⑦ Relative readout button
- ⑧ °C , °F control button

4. Operation Instructions:

4.1 Power-Up

Press the **⏻** key to turn the thermometer ON or OFF

4.2 Connection the temperature probe

For measurement, plug the temperature probe into the input connectors.

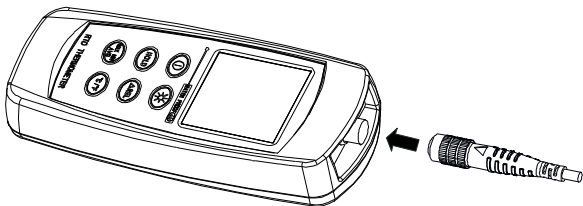

4.3 Selecting the Temperature Scale

When the meter was first power on, the default scale setting is set at Celsius ($^{\circ}\text{C}$) scale. The user may change it to Fahrenheit ($^{\circ}\text{F}$) by pressing " $^{\circ}\text{C}/^{\circ}\text{F}$ " button and vice versa to Celsius.

4.4 Data-Hold Operation

The user may hold the present reading and keep it on the display by pressing the "**HOLD**" button. When the hold data is no longer needed, one may release the data-hold operation by pressing "**HOLD**" button again.

When the meter is under Data Hold operation, the "**▲ REL**",  and " $^{\circ}\text{C}/^{\circ}\text{F}$ " button are disabled.

4.5 Back light Operation:

Press the "Back Light" button will turn back light on and Press it once again will turn off.

The meter will turn back light off if there is no push "Back Light" button for 10 seconds.

4.6 Relative Operation:

When one press the “ Δ REL” button, the meter will memorize the present reading and the difference between the new reading and the memorized data will be shown on the display. Press the “ Δ REL” button again to exit the Relative operation.

4.7 MAX/MIN/AVG Operation:

When one press the  button the meter will enter the MAX/MIN/AVG mode. Under this mode the maximum value, minimum value and average value of latest 8 data is kept in the memory simultaneously and updated with every new data.

When the MAX symbol is display, the Maximum is shown on the display.

Press  again, then the MIN symbol is on the display and also the minimum reading.

Press  again, the AVG symbol is on the display and also the average reading.

Press  again, MAX, MIN and AVG will blink together. This means that all these data is updated in the memory and the reading is the present temperature.

One may press  to circulate the display mode among these options.

When the meter is under  operation, “ Δ REL” and “ $^{\circ}\text{C}/^{\circ}\text{F}$ ” are disabled.

To exit the MAX/MIN mode, one may press and hold  for two seconds.



4.8 Auto Power Off:

By default, when the meter is powered on, it is under auto power off mode. The meter will power itself off after 30 minutes if no key operation.

One may press and hold “HOLD” button and then power on the meter and there will be two successive beeps to indicate that auto power off is disabled.

4.9 Low Battery Condition:

The temperature meter incorporates visual low battery indication as follows:

	Battery OK, measurements are possible.
	Battery Low, battery needs to be replaced, measurements are still possible.
	Battery exhausted, the battery need to replaced with new one(size AAA, 1.5V x 3).

5. Temperature Measurement

5.1 Correct Measurement Method:

The temperature sensor is located at the end of the metal sheath of the sheath type TEMPERATURE PROBE. To accurately test internal temperature insert the probe into the item you want to measure to a distance at least 15 times the diameter of the sheath.

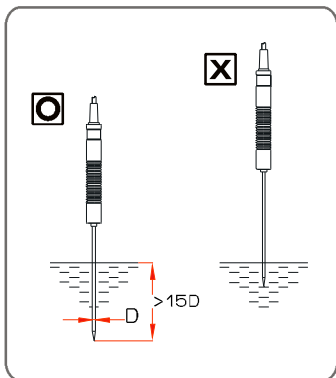

5.2 Connector Configuration:

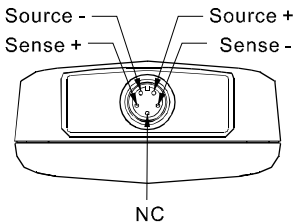

6. Temperature Meter Calibration Setup

Below table diagram shows each button function when user enter into calibration mode.

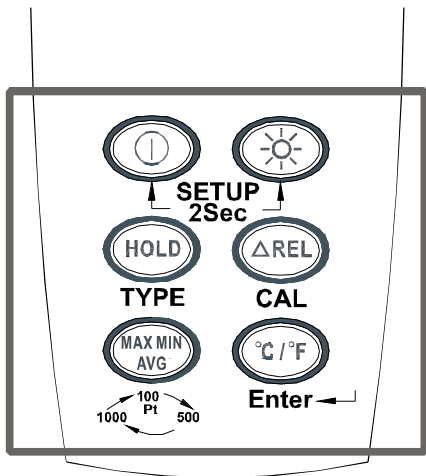

Note:

Turn the Power "OFF" before attempting following SETUP.
Setup mode is cancelled during below procedure if "POWER" button is pressed.

6.1 Pt type selection

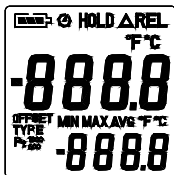

6-1-1.

Press and hold "Power" + "Light" buttons for 2 seconds to enter setup mode.

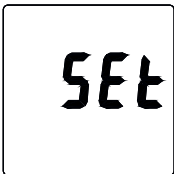

6-1-2.

Press "Hold" button to enter Pt selection mode.

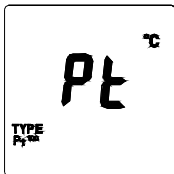

6-1-3.

Press "Max" button to select between Pt probe type.
(Pt100, Pt500, Pt1000 is circulate)

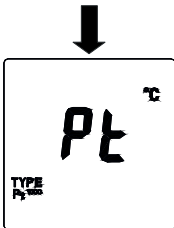

6-1-4.

Press "°C/°F" button to confirm selection.

6.2 0 °C Calibration

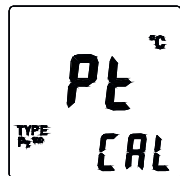
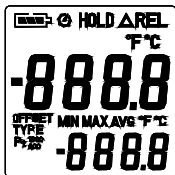

⚠ Insert temperature probe into 0°C Deg. Standard calibration unit before calibration. Hold the probe until condition is stabilized before starting calibration.

6-2-1.

Press and hold "Power" + "Light" buttons for 2 seconds to enter setup mode.

6-2-2.

Press "REL" button to enter calibration mode. Enter Pt selection first.

6-2-3.

Press "°C/°F" button to confirm Pt selection

6-2-4.

Press "REL" button to enter calibration mode.

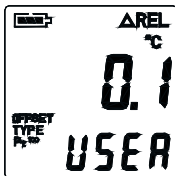

6-2-5.

Press "REL" button to confirm present calibration value.

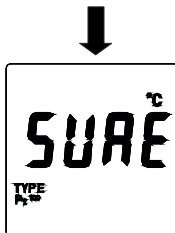

6-2-6.

Press "°C/°F" button to confirm selection.

6.3 Recall Default factory setting value

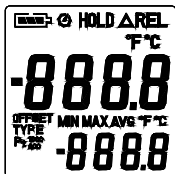

6-3-1.

Press and hold "Power" + "Light" buttons for 2 seconds to enter setup mode.

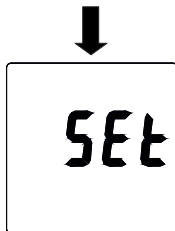

6-3-2.

Press "REL" button to enter calibration mode. Enter Pt selection first.

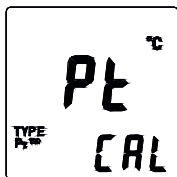

6-3-3.

Press "°C/°F" button to confirm Pt selection

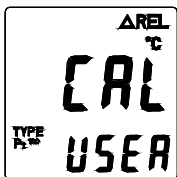

6-3-4.

Press "Light" button to enter recall mode.



6-3-5.

Press "°C/°F" button to confirm revert back to "Default factory setting value"



6-3-6.

Press "°C/°F" button to confirm selection.

7. Maintenance

■ Replacing the Batteries

- (1) Remove back cover screw to remove cover. Verify polarity and install new LR03(AAA size) alkaline batteries.
- (2) Fit cover properly and tighten screw.

⚠ *The unit's back cover are fitted with rubber rings. After replacing the battery, check that the rubber rings are properly seated before reinstalling the back cover. Improper seating of the rubber rings will compromise the unit's water-resistant structure, and possibly result in damage to the equipment.*

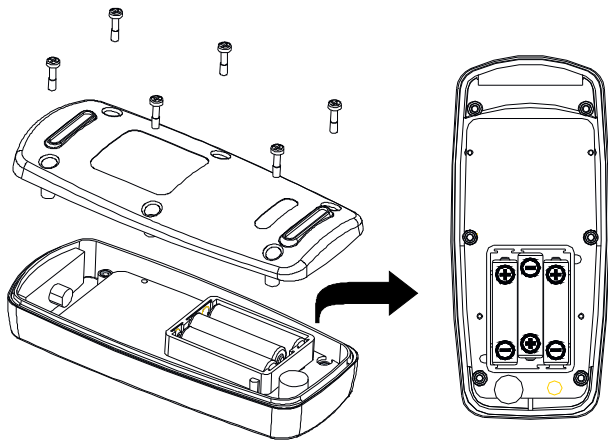

■ Cleaning

In order to ensure the accuracy of the thermometer for a longer period of time you should calibrate it once a year.

Clean the device and the window of the display with a clean, lint-free, antistatic and dry cleaning cloth.



Do not use cleaning agents that contain carbon or benzenes, alcohol or anything similar to clean the product since these substances damage the surface of the measuring instrument. Moreover, these fumes are hazardous to health and explosive. Do not use tools with sharp edges, screwdrivers, metal brushes or anything similar to clean the device.

8. Temperature Probe

8.1 Piercing type temperature probe

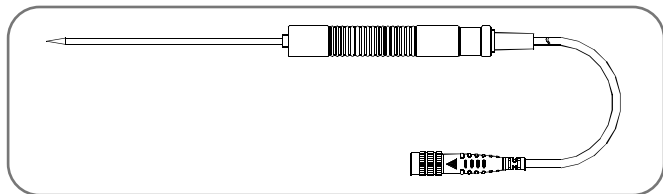

8.2 Piercing type temperature probe Specification

Sensor Type	Platinum resistance thermometer sensor Pt 100(4 wires)
Accuracy	IEC751, class A $\pm 0.15^{\circ}\text{C} \pm 0.002t$ (t: measurement temperature)
Measurement Range	-100 to 400°C
Temperature Sensor Dimensions	Approx. $\varnothing 3.2\text{mm}(\varnothing 0.125\text{'})$
Temperature Sensor Length	Approx. 120 mm(4.72")
Cable Length	Approx. 1100 mm(43.3")
Water-resistant	EN60529:1991 IP67

CENTER[®] CENTER TECHNOLOGY CORP.

4 / F NO. 415, Jung-Jeng Rd., 238 Shu-Lin, Taipei, Taiwan

E-Mail : center@centertek.com

[http : // www.centertek.com](http://www.centertek.com)

370-00
