

PM491

SAINT WIEN DIGITAL PANEL METER

PM491- IS A LOW COST HIGH PRECISION 3 1/2 DIGITS PANEL METER FOR VOLTAGE & CURRENT WITH OPTIONS OF HIGH/LOW SETTING/OUTPUT. DISPLAY PV OUTPUT, DISPLAY METER with USER PRE SCALE IS AVAILABLE

■ SPECIFICATIONS & CHARACTERISTICS

- 1- ACUURACY:+0.2-0.5%+1C (3 TIMES/S)
- 2- POWER SOURCE:110/220VAC DUAL +10% 2-4VA
- 3- INPUT IMPEDANCE: V=1M-10MΩ, A=0.01-100Ω
- 4- DISPLAY:0.56"(SETTING METER 0.39") 3 1/2 DIGITS
- 5- DECIMAL POINT (DP):USER SELECTABLE with jumper
- 6- PRE SCALE (PS) AVAILABLE FOR DISPLAY METER only for 5AAC(CT), 50mVDC(SHUNT),5VDC, 10VDC, 4-20mADC INPUT. PS range IS 5%-200% OF ORIGINAL DISPLAY 1000 IN STEP OF 5%. PS SW on LED PCB. -OPTION
- 7- HI LO SETTING:CODE SW(1) OR TRIM POT(2). OUTPUT:1C RATING 3A250VAC-OPTION PHOTO ISOLATED PV OUTPUT: Y=0-5V or Z= 4-20mA (+2%)-OPTION
- 8-12V UNREGULATED SOURCE FOR SENSOR or 4-20mA TRANSMITTER-OPTION
- 9-SELF TEST SW to CHECK SET value, slide TEST SW on LED panel to left then push Hi or Lo PB to read the SV-OPTION



■ ORDERING INFORMATION

- 1-PM491-VD3-H1L2-Z – PHOTO ISOLATED PV OUTPUT Y=0~5V. Z=4~20mA
- H=HIGH, L=LOW. NO HIGH LOW IS NO SETTING/OUTPUT SETTING METHOD 1=CODE SW, 2=TRIM POT
 - IF H1L1=BOTH HIGH LOW IS CODE SW SETTING
 - IF H1L2=HIGH IS CODE SW, LOW IS TRIM POT SETTING
 - RANGE V:1=199.9mV,2=1.999V, 3=19.99V, 4=199.9V,5=1000V
 - A:1=1.999mA,2=19.99mA,3=199.9mA,4=1.999A,5=10.00A
 - INPUT SIGNAL:A=AC SINE WAVE, D=DC
 - INPUT SIGNAL:V=VOLTAGE, A=CURRENT

- 2-PM491-XXX/XXX-H1L2-Z –PHOTO ISOLATED PV OUTPUT Y=0~5V, Z=4~20mA
- H=HIGH, L=LOW. NO HIGH LOW IS NO SETTING/OUTPUT
 - INPUT SIGNAL V=VOLTAGE, A=CURRENT, A=AC, D=DC
 - DISPLAY RANGE & UNIT (INDIRECT INPUT)

- 3-PM491-1000X/XXX... Factory calibrated & user programmable display
- 5AAC CT to isplay AC load
 - 50mVDC shunt to display DC load
 - 10VDC to display Hz/RPM/Line speed of frequency converter
 - 4-20mA to display process value of sensor/transmitter
 - Display 1000 with PS 5~200% user programmable display meter

■ DIMENSIONS (mm) & MOUNTING BRACKET

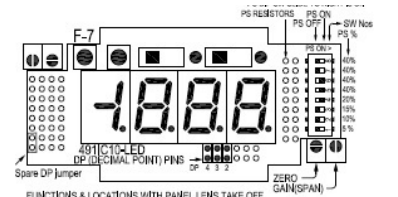
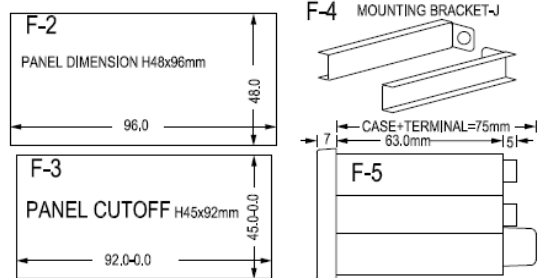

■ CONNECTION DIAGRAM, PS SW ON DISPLAY PCB. (F6, F7)

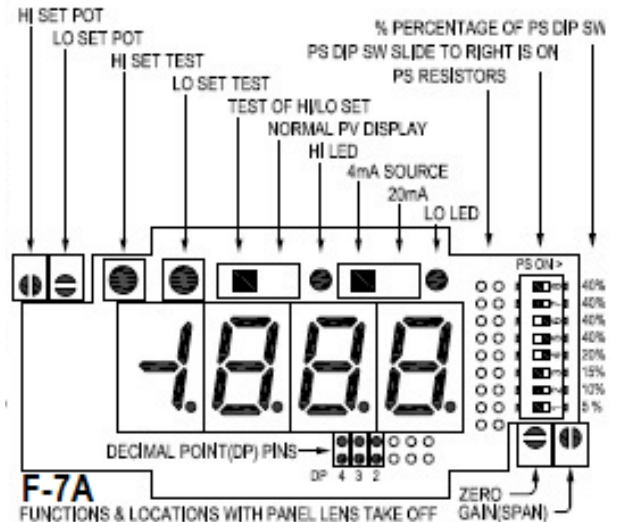
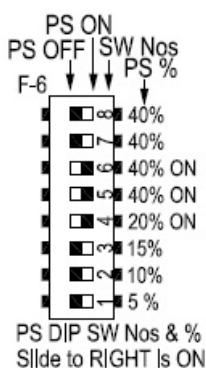
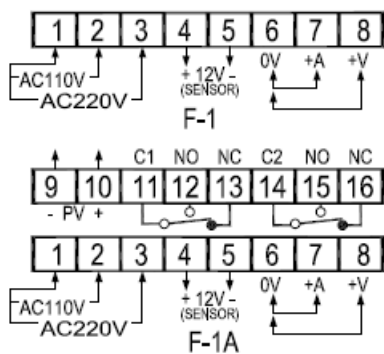

■ PRE-SCALE (PS) CALCULATING, PROGRAMMING NEW DISPLAY OF PM491-1000X/XXX. & DECIMAL POINT (DP)

PM491-1000X/XXX IS USER PROGRAMMABLE DIGITAL PANEL METER. USER MAY SIMPLY PROGRAM THE NEW DISPLAY VALUE IN ACCORDING TO USER'S APPLICATION . BY USING 8-PIN DIP SW TO PROGRAM NEW DISPLAY VALUE IS 5%-200% OF ORIGINAL VALUE.

THE ORIGINAL DISPLAY is 1000 (FACTORY CALIBRATED) for all inputs of 5AAC, 50mVDC,10VDC or 4-20mADC

REMOVE PANEL LENS TO ACCESS PS DIP SW & PINS/JUMPER (for DP) ON LED PCB

PS DIP SW SLIDE TO RIGHT HANDSIDE IS "PS ON". It denote the NEW DISPLAY VALUE is THIS percentage of THE ORIGINAL DISPLAY.

PS DIP SW Nos DENOTE percentage TO THE ORIGINAL DISPLAY. DIP SW Nos 1=5%, 2=10%, 3=15%, 4=20%, 5=40%, 6=40%, 7=40%, 8=40%

DIP SW SLIDE TO RIGHT IS "ON". ORIGINAL DISPLAY 1000 IS WITH PS DIP SW Nos OF 4(20%), 5(40%), 6(40%) "ON" (SLIDE TO RIGHT HANDSIDE)

EXAMPLE1 : PM491-1000X/5AAC to display current of CT150.0A/5AAC

Original display is 1000 & the PS is 100%(20%+40%+40%).

New display is 1500. The new PS must be 150%. PS SW Nos of 2,4,5,6,7 must be ON. The weight of SW Nos of 2,4,5,6,7 is 10%,20%, 40%, 40% & 40% respectively. The sum of these PS's percentage is the new display and equal to 10+20+40+40+40=150(%). The meter will show 1500 when apply 5AAC to input. Then place the jumper to DP pin at 2. The new display now is 150.0(AAC)

EXAMPLE2 : PM491-1000X/50mV to display current of shunt 300A/50mV

Original display is 1000 for 50mV. New display is 300. PS must be $300/1000=30\%$ of original. PS SW of 10%, 20% slide ON.

- 3- **PM491-1000X/XXX**..1000X is Factory calibrated & user PROGRAMMABLE DISPLAY for assigned INPUT(XXX) of 5AAC, 50mVDC,10VDC or 4~20mA.
- A PM491-1000X/5AAC:TO DISPLAY AC LOAD CURRENT WITH CT 5AAC INPUT.
 - B PM491-1000X/10VDC: TO DISPLAY RPM OR HZ OR LINE SPEED OF THE FREQUENCY CONVERTER OR PROCESS VALUE OF TRANSMITTER, SENSOR WITH 10VDC OUTPUT (OR OTHERS 5VDC upon request).
 - C PM491-1000X/50mVDC: TO DISPLAY THE DC CURRENT WITH SHUNT INPUT 50mV (OR OTHERS upon request).
 - D PM491-1000X/(4-20mADC): TO DISPLAY THE PROCESS VALUE OF TRANSMITTER or SENSOR WITH 4~20mA OUTPUT.

3- **PM491-1000X/XXX**..1000X is Factory calibrated & user PROGRAMMABLE DISPLAY

for assigned INPUT(XXX) of 5AAC, 50mVDC,10VDC or 4~20mA.

- A PM491-1000X/5AAC:TO DISPLAY AC LOAD CURRENT WITH CT 5AAC INPUT.
- B PM491-1000X/10VDC: TO DISPLAY RPM OR HZ OR LINE SPEED OF THE FREQUENCY CONVERTER OR PROCESS VALUE OF TRANSMITTER, SENSOR WITH 10VDC OUTPUT (OR OTHERS 5VDC upon request).
- C PM491-1000X/50mVDC: TO DISPLAY THE DC CURRENT WITH SHUNT INPUT 50mV (OR OTHERS upon request).
- D PM491-1000X/(4-20mADC): TO DISPLAY THE PROCESS VALUE OF TRANSMITTER or SENSOR WITH 4~20mA OUTPUT.

=DISPLAY PRE SCALE PROGRAMMABLE FOR 5AAC,
The sum of all PS is the new display.

FROM 5% to 200% OF THE ORIGINAL DISPLAY 1000 (FACTORY CALIBRATED) IN STEP OF 5% BY USING 8 PINS
DIP SW.

REMOVE PANEL LENS TO ACCESS DIP SW & PINS/JUMPER (for DP).

PS DIP SW Nos DENOTE percentage TO THE ORIGINAL DISPLAY. DIP SW Nos 1=5%, 2=10%, 3=15%, 4=20%, 5=40%, 6=40%, 7=40%, 8=40%

DIP SW SLIDE TO RIGHT IS "ON". ORIGINAL DISPLAY 1000 IS WITH PS DIP SW Nos OF 4(20%), 5(40%), 6(40%) "ON" (SLIDE TO RIGHT HANDSIDE)

PS CALCULATING FORMULAR: (NEW DISPLAY)/1000=PERCENTAGE FOR NEW DISPLAY.

SET THE SUM OF PS SW'S Nos' NUMBERS (PINS OPEN ARE IN USE) EQUAL TO THIS PERCENTAGE.

- 1 PM491-1000X/5AAC NORMALLY USED TO DISPLAY AC LOAD CURRENT WITH CT 5AAC INPUT.
- 2 PM491-1000X/10VDC NORMALLY USED TO DISPLAY RPM OR LINE SPEED OR HZ OF THE FREQUENCY CONVERTER SIGNAL OR PROCESS VALUE OF TRANSMITTER, SENSOR WITH 10VDC OUTPUT (OR OTHERS 5VDC).
- 3 PM491-1000X/50mVDC NORMALLY USED TO DISPLAY THE DC CURRENT WITH SHUNT INPUT 50mV (OR OTHERS).
- 4 PM491-1000X/(4-20mADC) NORMALLY USED TO DISPLAY THE PROCESS VALUE OF TRANSMITTER & SENSOR WITH 4~20mA OUTPUT.

EXAMPLE 4: 1000X/XXX=DISPLAY PRE SCALE PROGRAMMABLE FOR 5AAC, 50mVdc,10vdc,4~20mADC INPUT

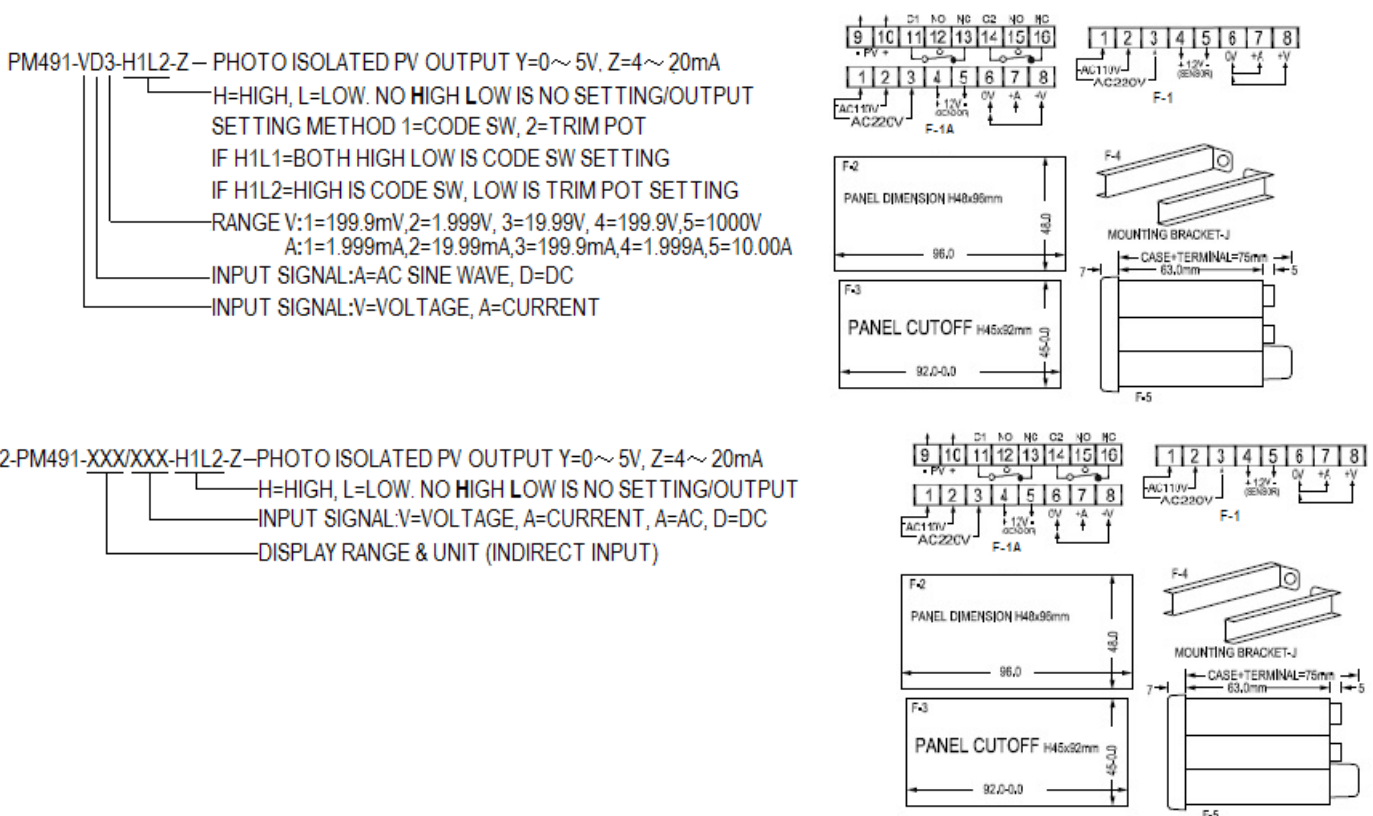

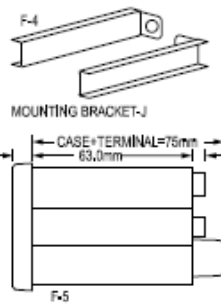
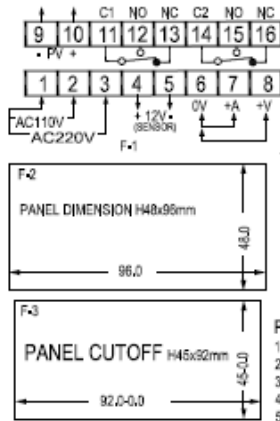

PS CALCULATING AND SETTING

- 1 ORIGINAL DISPLAY 1000 IS WITH PS 40, 40 & 20 ON=100%
- 2 PS SW NOS 1=5, 2=10, 3=15, 4=20, 5=40, 6=10, 7=40, 8=20%
- 3 FORMULAR; PS% FOR NEW DISPLAY=(NEW DISPLAY)/1000
- 4 IF NEW DISPLAY IS 500 THEN PS %=(500/1000)=50%
5. Keep PS SW Nos of 2=10% & 5=40% ON, others OFF

