

FP93

Program Controller

Instruction Manual

Thank you for purchasing a Shimaden product. Please check that the delivered product is the correct item you ordered. Please do not begin operating this product before you read this instruction manual thoroughly and understand its contents.

"Notice"

Please ensure that this instruction manual is given to the final user of the instrument.

"Preface"

This instruction manual is meant for those who will be involved in the wiring, installation, operation and routine maintenance of the FP93. It describes matters to be attended to in handling the FP93, how to install it, wiring, its functions and operating procedure. Keep this manual at the work site while handling the instrument and follow the guidance provided herein

Contents

	page		page
1. Safety Rules	3	5-9. Explanation of Screen Group 4 and Setting	18
2. Introduction	4	(1) Setting Outputs of PID Nos. 1~6	18
2-1. Check before Use	4	(2) Setting Zone PID	18
2-2. Handling Instruction.	4	5-10. Explanation of Screen Group 5 and Setting	19
3. Installation and Wiring	4	(1) Setting the Number of Patterns.	19
3-1. Installation Site.	4	(2) Setting Time Unit	19
3-2. Mounting	5	(3) Setting With/ Without Power Failure Compensation	19
3-3. External Dimensions and Panel Cutout	5	(4) Setting Input Abnormality Mode	19
3-4. Wiring.	5	(5) Setting Measuring Range Code	19
3-5. Terminal Layout	6	(6) Setting Input Unit	19
3-6. Terminal Arrangement Table	6	(7) Setting Input Scaling	19
4. Names and Functions of Parts on Front Panel	7	(8) Setting PV Bias.	19
5. Explanation of Screens and Setting	9	(9) Setting PV Filter.	19
5-1. Parameter Flow.	9	(10) Setting Output Control Characteristics	20
(1) How to Move from Screen Group to Screen Group and Explanation of Screen Groups	9	(11) Setting Proportional Cycle	20
5-2. Application of Power and Display of Initial Screen.	13	(12) Setting SV Limiter	20
5-3. How to Change Screens	13	(13) Setting External Control Input	20
(1) How to Change Screen Groups 0~5	13	(14) Setting Events.	20
(2) How to Change Screens in Screen Group 0	13	(15) Setting Status Output (DO)	21
(3) How to Change Screens in Screen Group 3	14	(16) Setting Analog Output	21
(4) How to Change Set Values (Data)	14	(17) Setting Communication	21
5-4. Before Starting Up	14	(18) Setting Keylock	22
(1) Checking Wiring	14	5-11. Measuring Range Codes Table.	22
(2) Applying Power	14	6. Operation and Functions	23
(3) Setting Measuring Range	14	6-1. Using FIX Mode.	23
(4) Setting Control Mode	14	6-2. Setting Target Value (SV)	23
(5) Setting Control Output Characteristic	14	6-3. Setting Output Manually	23
(6) Setting Other Data	14	6-4. Auto Tuning (AT).	24
(7) Note on Initialization upon Change of Data.	14	6-5. PID Action	24
5-5. Explanation of Screen Group 0 and Setting	15	6-6. Manual Reset	24
(1) Setting HLD Execution	15	6-7. Output Lower Limit and Higher Limit Setting Limiters	24
(2) Setting ADV Execution	15	6-8. Proportional Cycle Time	24
(3) Setting Auto Tuning (AT) Execution.	15	6-9. Zone PID.	25
5-6. Explanation of Screen Group 1 and Setting	15	6-10. External Control Input (DI)	25
(1) Setting Start SV	15	6-11. Events	26
(2) Setting End Step.	15	6-12. Setting Event Standby Action	26
(3) Setting Time Signal	16	6-13. Diagrams of Alarm Actions Selectable as Event	26
(4) Setting Event Action Point.	16	6-14. Event and Status Output Actions	26
(5) Setting the Number of Program Executions.	16	6-15. Time Signal	27
(6) Setting PV Start	17	6-16. Status (DO) Output.	28
(7) Setting Guarantee Soak Zone	17	6-17. Auto Return Function.	28
5-7. Explanation of Screen Group 2 and Setting	17	6-18. Notes on RAM as Communication Memory Mode	28
(1) Setting Step SV.	17	7. Error Codes, Causes and Remedies	28
(2) Setting Step Time.	17	8. Record of Parameter Setting	29
(3) Setting PID No.	17	9. Specifications.	33
5-8. Explanation of Screen Group 3 and Setting	17		
(1) Setting ON/OFF of FIX Mode	17		
(2) Setting FIX SV Value.	17		
(3) Setting FIX No.	17		
(4) Setting FIX Event Action Point	17		

1. Safety Rules

For matters regarding safety, potential damage to equipment and/or facilities, additional instructions and notes are indicated by the following headings.

WARNING

This heading indicates hazardous conditions that could cause injury or death of personnel unless extreme caution is exercised.

CAUTION

This heading indicates hazardous conditions that could cause damage to equipment and/or facilities unless extreme caution is exercised.

Note

This heading indicates additional instructions and/or notes.

The mark  represents a protective conductor terminal. Make sure to ground it properly.

WARNING

The FP93 digital controllers are control instruments designed for industrial use to control temperature, humidity and other physical values. Avoid using it for control of devices which may seriously affect the human life. When used, adequate and effective safety measures must be taken. No warranty is valid in the case of an accident arising from the use of this product without such safety measures.



WARNING

- For using this instrument, house it in a control box or the like lest terminals should be in contact with a person.
- Don't draw out the instrument from the case. Don't let your hand or a conductive body in the case. It may lead to serious injury or death due to an electric shock.
- Make sure to ground protective conductor terminals.

CAUTION

To avoid damage to connected equipment, facilities or products due to a fault of the product, safety measures must be taken before usage, such as the installation of a fuse, an overheating protection device and the like. No warranty is valid in the case of an accident arising from the use of this product without such safety measures.

CAUTION

- The  mark on the plate affixed to the instrument:
On the terminal nameplate affixed to the case of this instrument, the alert mark  is printed. This is to warn you of the risk of electric shock which may result if the charger is touched while being energized.
- As a means to turn the power off, a switch or a breaker should be installed in the external power circuit to be connected to the power terminal of the instrument. Fix the switch or the breaker adjacently to the instrument in a position which allows it to be operated with ease, with an indication that it is a means of turning the power off. Use a switch or a breaker which meets the requirement of IEC60947.
- Fuse:
Since the instrument does not have a built-in fuse, do not forget to install a fuse in the power circuit to be connected to the power terminal. A fuse should be positioned between a switch or a breaker and the instrument and mounted on the L side of the power terminal.
Fuse rating/characteristics: 250V AC 1A/medium lagged or lagged type.
Use a fuse which meets the requirement of IEC60127.
- Voltage/current of a load to be connected to the output terminal and the alarm terminal should be within a rated range. Otherwise, the temperature will rise to reduce the life of product and/or to result in problems with the product. For rated voltage/current, see "9. Specifications" of this manual.
The output terminal should be connected with a device which meets the requirements of IEC61010.
- A voltage/current different from that of the input specification should not be applied to the input terminal. It may reduce the life of the product and/or result in problems with the product. For rated voltage/current, see "9. Specifications" of this manual.
In the case of voltage or current input, the input terminal should be connected to a device which meets the requirement of IEC61010.
The instrument is provided with a draft hole for heat discharge. Take care to prevent metal and other foreign matters from getting into it. Failure to do so may result in trouble with the instrument or may even cause a fire.
- Don't block the draft hole or allow dust or the like to stick to it. A rise in temperature or insulation failure may result in a reduction of the life of the product and/or problems with it or may cause a fire.
For spaces between installed instruments, refer to "3-3. External Dimensions and Panel Cutout."
- It should be noted that repeated tolerance tests against voltage, noise, surge, etc. may lead to deterioration of the instrument.
- Users are prohibited from remodeling the product or abnormal use of it.

3-2. Mounting

⚠ CAUTION

For safety's sake and to protect the functionality of the product, don't draw out its body from the case. If it needs to be drawn out for replacement or repair, contact our sales agent.

- ① Cut a hole for mounting the controller in the panel by referring to the cutout drawing in Section 3-3.
- ② The panel thickness should be 1.0~4.0 mm.
- ③ As the instrument is provided with pawls for fixing, just press it firmly from the front of the panel. The case is fixed to the panel by means of the pawls.
- ④ The FP93 is designed as a panel-mounting model. Never use it without mounting on the panel.

3-3. External Dimensions and Panel Cutout

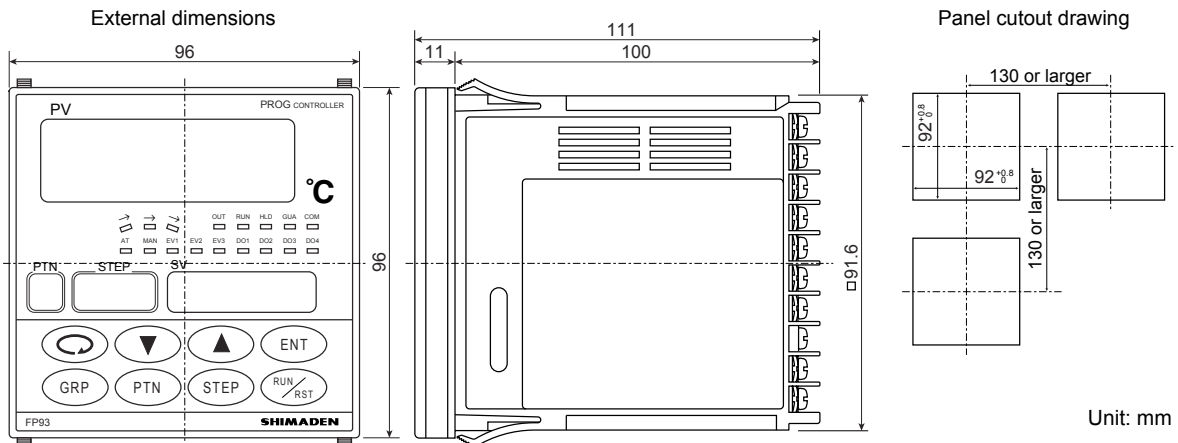

3-4. Wiring

In wiring operation, close attention should be paid to the following:

⚠ CAUTION

- Make sure to disconnect this instrument from any power source during wiring operation to prevent an electric shock.
- Be certain that the protective conductor terminal (⊕) is properly grounded. Otherwise, an electric shock may result.
- To prevent an electric shock, don't touch wired terminals and other charged elements while they are being energized.

- ① In wiring operation, follow the terminal layout shown in Section 3-5 and the terminal arrangement in Section 3-6 and make sure to carry out the correct wiring.
- ② Use press-fit terminal which fits an M3.5 screw and has a width of 7 mm or less.
- ③ In case of thermocouple input, use a compensating cable compatible with the selected type of thermocouple.
- ④ In the case of R.T.D. input, the resistance of a single lead wire must be 5 Ω or less and the three wires must have the same resistance.
- ⑤ The input signal wire must not be accommodated with a high-voltage power cable in the same conduit or duct.
- ⑥ Shield wiring (single point grounding) is effective against static induction noise.
- ⑦ Twisting the input wires at short and equal intervals is effective against electromagnetic induction noise.
- ⑧ In wiring for power supply, use a wire or cable whose performance is equal to or higher than the 600V vinyl insulated wire having a sectional area of 1 mm² or larger.
- ⑨ The wire for grounding must have a sectional area of 2 mm² or larger and must be grounded at a grounding resistance of 100 Ω or less.
- ⑩ Clamp the screws of terminals firmly. Clamping torque: 1.0 N · m (10kgf · cm)
- ⑪ If the instrument appears to be easily affected by power supply noise, use a noise filter to prevent malfunctioning.
- ⑫ Mount the noise filter on the grounded panel and make wire connection between the noise filter output and the power line terminals of the controller as short as possible.

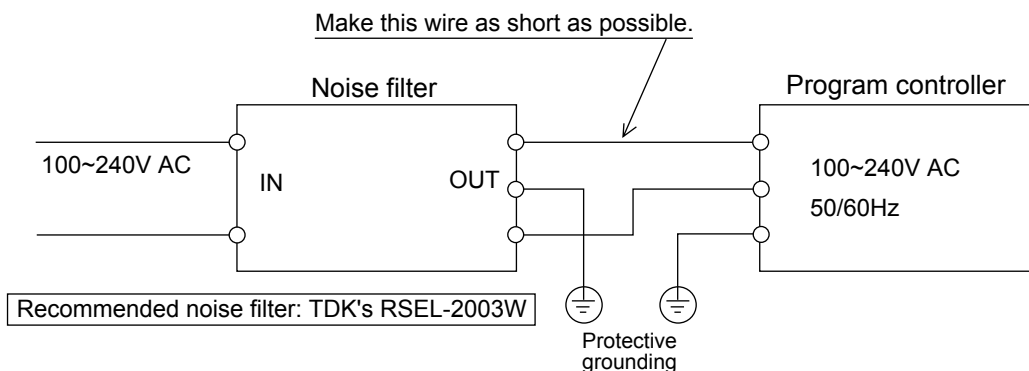

3-5. Terminal Layout (Follow the terminal layout and terminal arrangement table shown below in your wiring operation.)

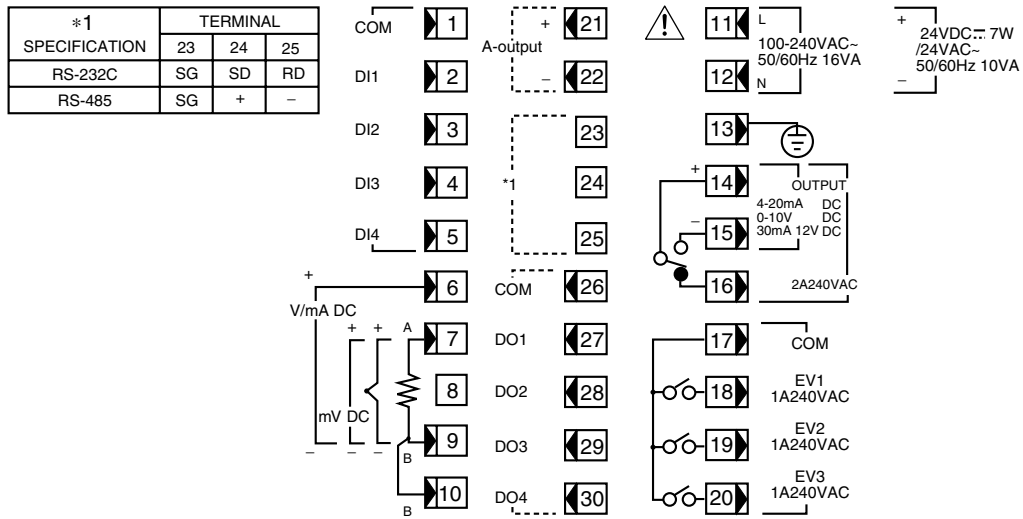

3-6. Terminal Arrangement Table

Name of terminal	Description/Code	Terminal No.
Power supply	100~240V AC/24V AC: L, 24V DC: +	11
	100~240V AC/24V AC: N, 24V DC: -	12
Protective conductor	Protective grounding ⊕	13
Input	Voltage (V) Current (mA): +	6
	R.T.D.: A, thermocouple/Voltage (mV): +	7
	R.T.D.: B, thermocouple/Voltage (mV, V), Current (mA): -	9
	R.T.D.: B	10
Control output	Contact: COM, SSR drive voltage/Voltage/Current: +	14
	Contact: NO, SSR drive voltage/Voltage/Current: -	15
	Contact: NC	16
Event output	COM	17
	EV1	18
	EV2	19
	EV3	20
Analog output (option)	+	21
	-	22
Communication (option)	SG	23
	RS-232C: SD, RS-485: +	24
	RS-232C: RD, RS-485: -	25
External control input	COM	1
	DI1	2
	DI2	3
	DI3	4
	DI4	5
Status output (DO) (option)	COM	26
	DO1	27
	DO2	28
	DO3	29
	DO4	30







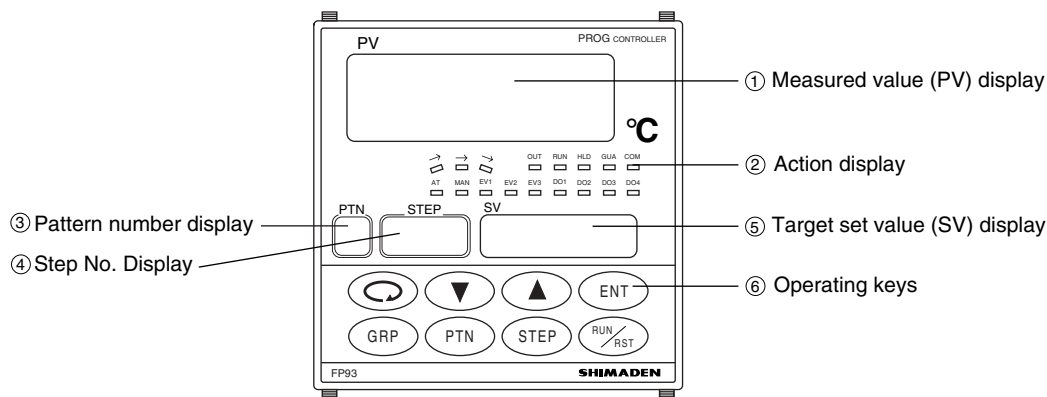



NOTE 1: With thermocouple, voltage, or current input, shorting across B and B terminal will cause an error. Leave terminal No.10 open.

NOTE 2: With voltage (V) or current (mA) input, don't connect anything with terminal No.7. Any connection with it may cause problems with the instrument.

4. Names and Functions of Parts on Front Panel



Name	Function
① Measured value (PV) display	(1) Present measured value is displayed in the screen group 0. (red) (2) Type of parameter is shown on each parameter screen.
② Action display	(1) → (green) Ascending action lamp • Lights while ascending step is in execution. (2) → (green) Level action lamp • Lights while level step is in execution. (3) ↘ (green) Descending action lamp • Lights while descending step is in execution. (4) OUT (green) Control output lamp • Lights when contact or SSR drive voltage output is ON, goes out when output turns OFF. • For current or voltage output, brightness increases or decreases in proportion to output. (5) RUN (green) RUN action lamp • Lights while program is in execution. • Blinks while FIX is in execution. (6) HLD (green) HLD action lamp • Lights when a brief suspension (Hold) is set while program is in execution. (7) GUA (green) GUA action lamp • Lights in case PV value does not reach a set range of deviation values when moving to level step during program execution (guarantee soak). (8) COM (green) Communication action lamp • Lights when COM mode is selected in case the instrument includes the communication option. The lamp does not light if local is selected as communication mode. (9) AT (green) Auto tuning action lamp • Blinks while AT is in execution. The lamp lights during standby for AT and goes out when AT action comes to an end or is terminated. (10) MAN (green) Manual control output action lamp • Blinks when manual control output is selected on output screen. The lamp remains extinct during automatic control output. (11) EV1 (orange) Event 1 output action lamp. Lights when event 1 turns ON. EV2 (orange) Event 2 output action lamp. Lights when event 2 turns ON. EV3 (orange) Event 3 output action lamp. Lights when event 3 turns ON. (12) DO1 (green) Status output 1 action lamp. Lights when status output 1 turns ON. DO2 (green) Status output 2 action lamp. Lights when status output 2 turns ON. DO3 (green) Status output 3 action lamp. Lights when status output 3 turns ON. DO4 (green) Status output 4 action lamp. Lights when status output 4 turns ON.
③ Pattern number display	(1) Pattern No. currently selected is displayed. (green)
④ Step No. Display	(1) Step No. currently in execution is displayed. (green) (2) Step No. currently set in screen group 2 is displayed. (3) PID No. currently set in screen group 4 is displayed.
⑤ Target set value (SV) display	(1) Target set value is displayed on the basic screen of screen group 0. (green) (2) Present output value is displayed in % on the output monitor screen of screen group 0. (3) Selected item and set value are displayed on each parameter screen.

Name	Function
⑥ Operating keys	<p>(1)  (parameter) key</p> <ul style="list-style-type: none"> Pressing this key on any screen calls the next screen onto display. Pressing this key continuously for 3 seconds calls the initial screen of screen group 5. <p>(2)  (up) key</p> <ul style="list-style-type: none"> Used to increase a numerical value on a numerical value setting screen. Used to select an item on an item selection screen. <p>(3)  (down) key</p> <ul style="list-style-type: none"> Used to decrease a numerical value on a numerical value setting screen. Used to select an item on an item selection screen. <p>(4)  (entry) key</p> <ul style="list-style-type: none"> Used to register a set data changed by means of the  or  key on each screen (the decimal point of the rightmost digit goes out). When pressed for 3 seconds continuously on output (OUT) screen, this key switches between automatic output and manual output. <p>(5)  (group) key</p> <ul style="list-style-type: none"> When pressed in the middle of setting in screen groups 1, 3, 4 or 5, the initial screen of the group is called onto display. When pressed in the screen group 2, the initial screen of screen group 1 is called onto display. When pressed on the basic screen, the display moves to screen group 1, screen group 3, screen group 4 and the basic screen in the order mentioned. When pressed on the initial screen of screen group 5, the basic screen is called. <p>(6)  (pattern) key</p> <ul style="list-style-type: none"> When pressed during stop (RST) on the basic screen, a starting pattern can be selected. It is registered by pressing the  key. This key is used to move to other screen groups. For details, see Section 5-1 or 5-5. <p>(7)  (step) key</p> <ul style="list-style-type: none"> This key is used to move to other screen groups. For details, see Section 5-1 or 5-5. <p>(8)  (run/reset) key</p> <ul style="list-style-type: none"> When pressed continuously for 3 seconds on the basic screen, execution (RUN) and stop (RST) are switched. When pressed in any of screen groups 1~5, the preceding screen is returned onto display.

5. Explanation of Screens and Setting

5-1. Parameter Flow

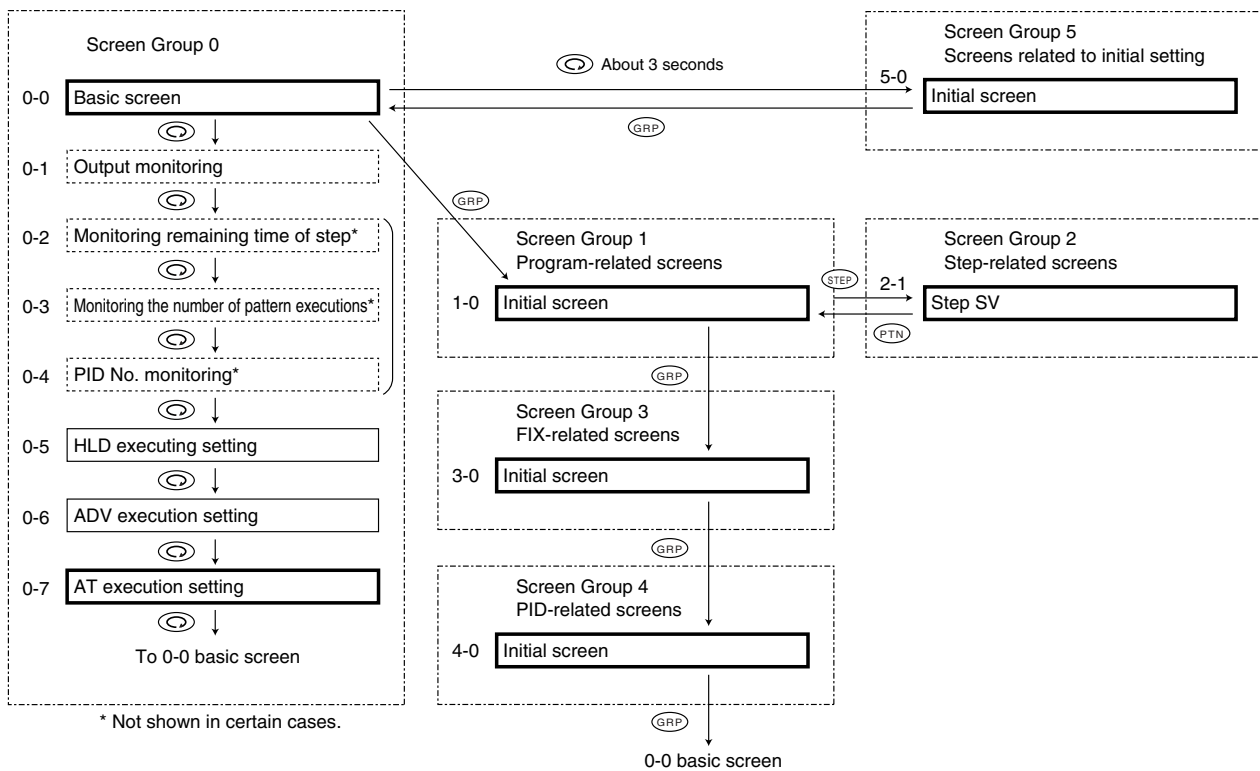
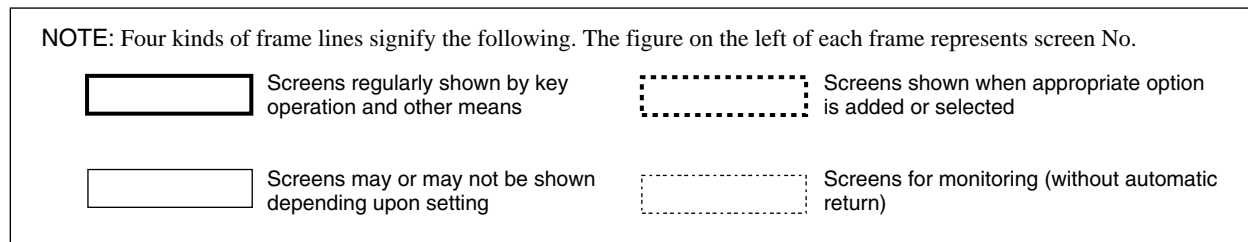

(1) How to Move from Screen Group to Screen Group and Explanation of Screen Groups

NOTE 1: To move among screen groups 0, 1, 3 and 4, press the **GRP** key on the basic screen of screen group 0 or the initial screens of screen group 1, 3 or 4.

NOTE 2: To move between screen groups 0 and 5, pressing the **⏻** key for 3 seconds continuously on the basic screen of screen group 0 calls the initial screen of screen group 5, and pressing the **GRP** key on the initial screen of screen group 5 calls the basic screen of screen group 0.

NOTE 3: Pressing the **⏻** key in any screen group calls the next screen and pressing it on the last screen of a screen group calls the initial screen.

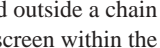
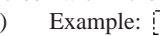
NOTE 4: A key shown above and outside a chain line frame () surrounding each screen group means that you can move from any of the screen within the frame to a designated screen by pressing that key. (This applies to screen groups 1, 2, 3, 4 and 5.) Example:  →

NOTE 5: The screen group 1 has patterns 1~4. (One pattern has 16 setting screens.) The number of patterns is selectable (which is set on the 5-1 screen; the initial value is 4).

NOTE 6: The screen group 2 has steps 1 to 40 (one step containing three setting screens). The number of steps is selectable (which is set on the 1-2 screen; the initial value is 10).

NOTE 7: The screen group 4 has 6 PID Nos. (each having 8 setting screens) and Zone PID.

NOTE 8: Within a screen group, you can move from screen to screen by pressing an appropriate key indicated in screen sequences (which are shown in the following page on).

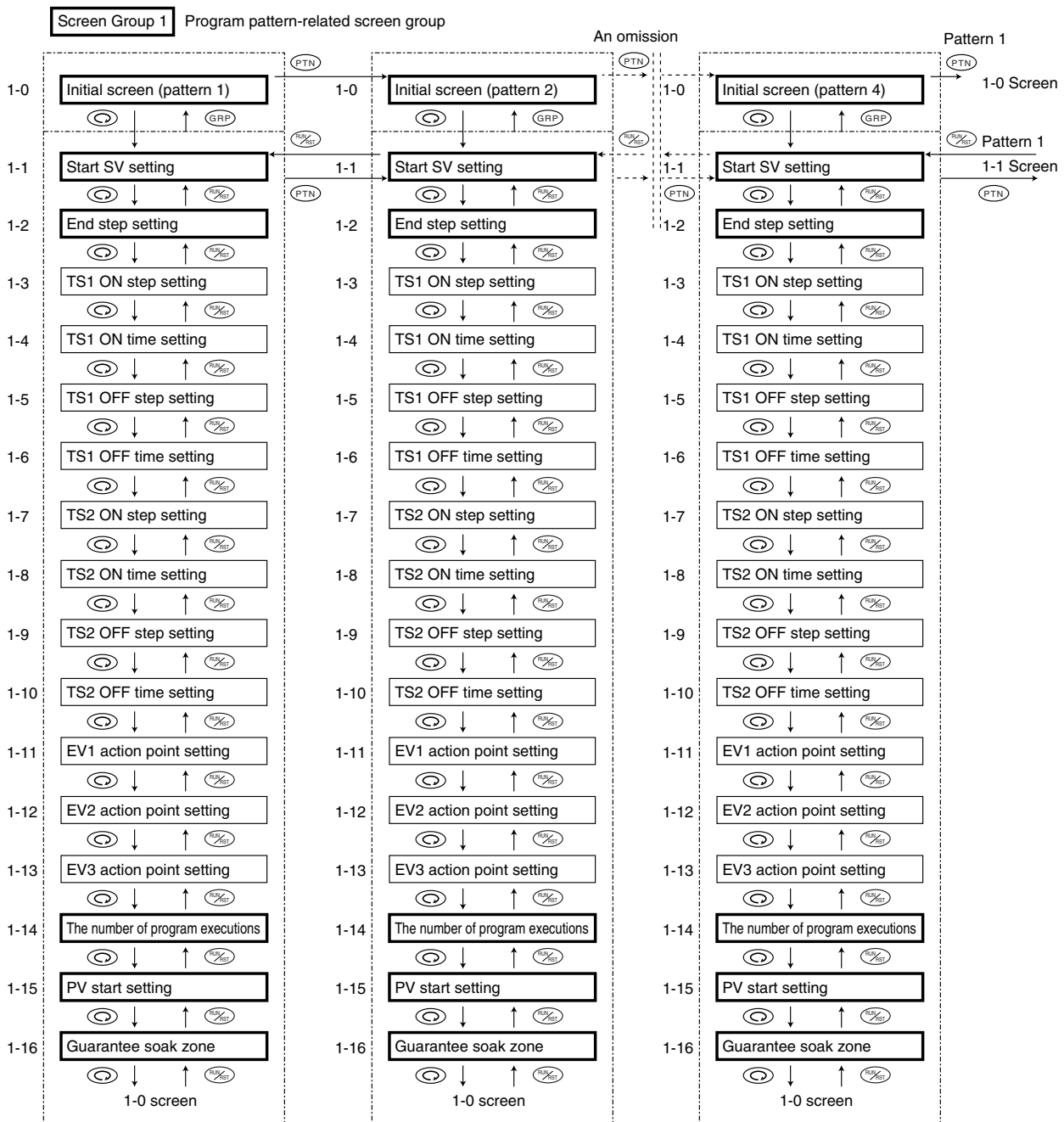

2-1 screen *1

2-1 screen *1

2-1 screen *1

*1: All screens 1-0 through 1-16

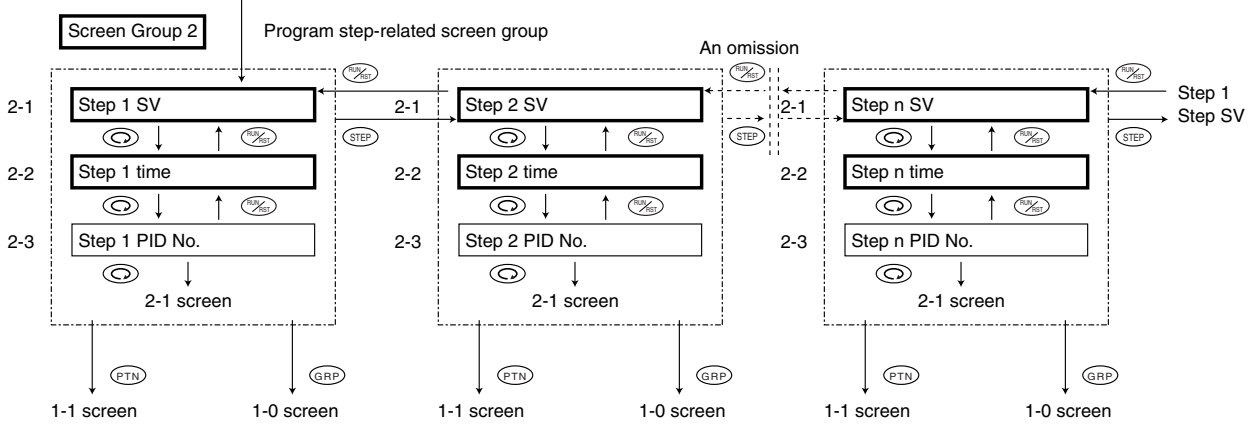

Screen Group 3 FIX-related screen group

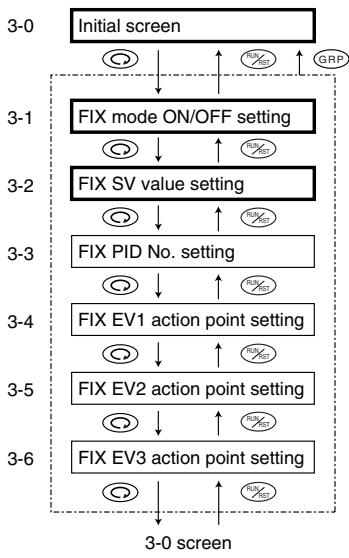

Screen Group 4 PID-related screen group

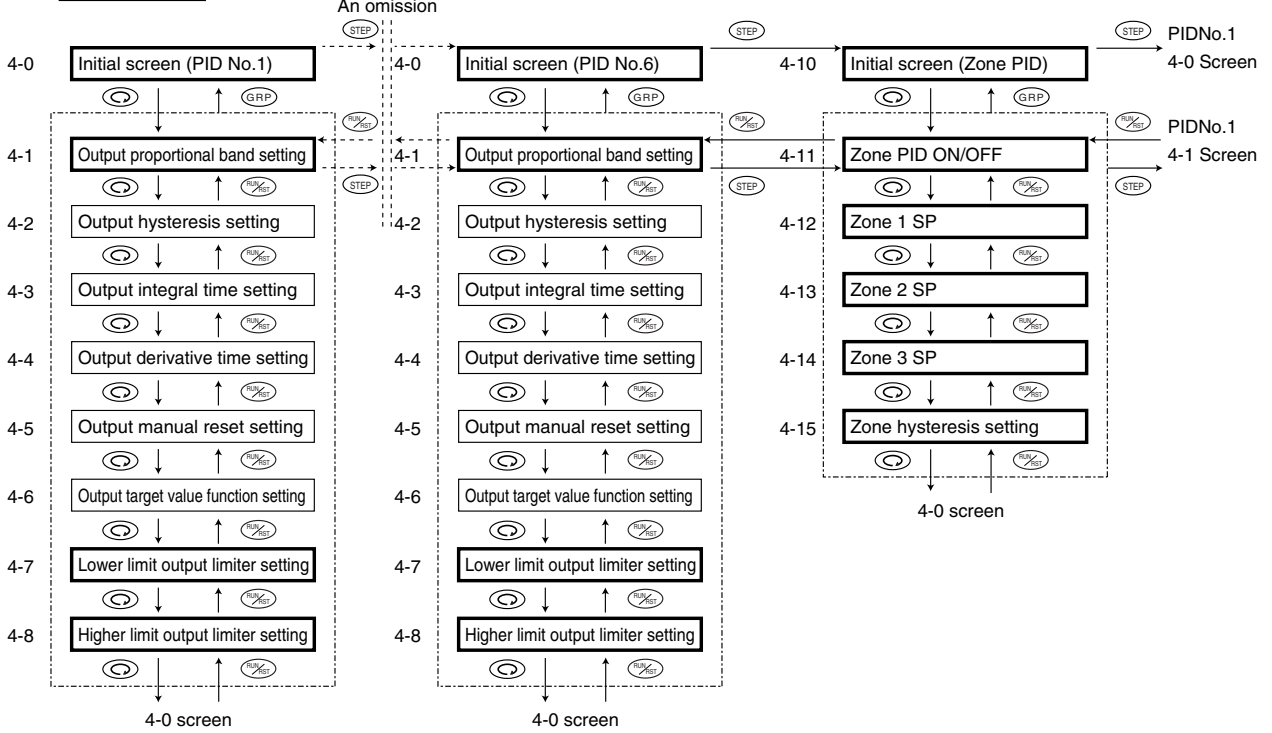

Screen Group 5 Initial setting screen group

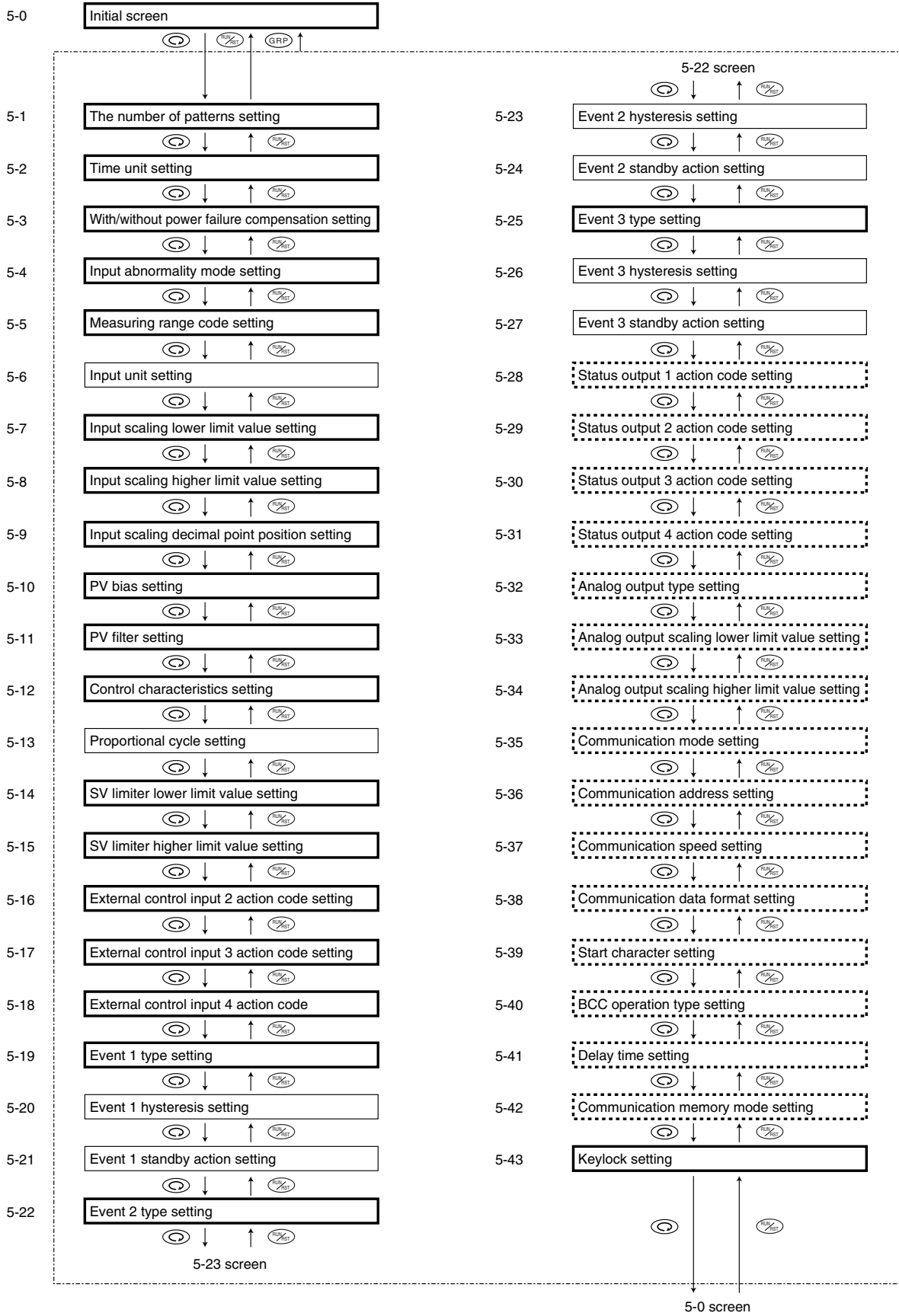

5-2. Application of Power and Display of Initial Screen

When power is applied, the initial screen and two screens are displayed successively, each for about 1 second as shown below. Then the basic screen is displayed.

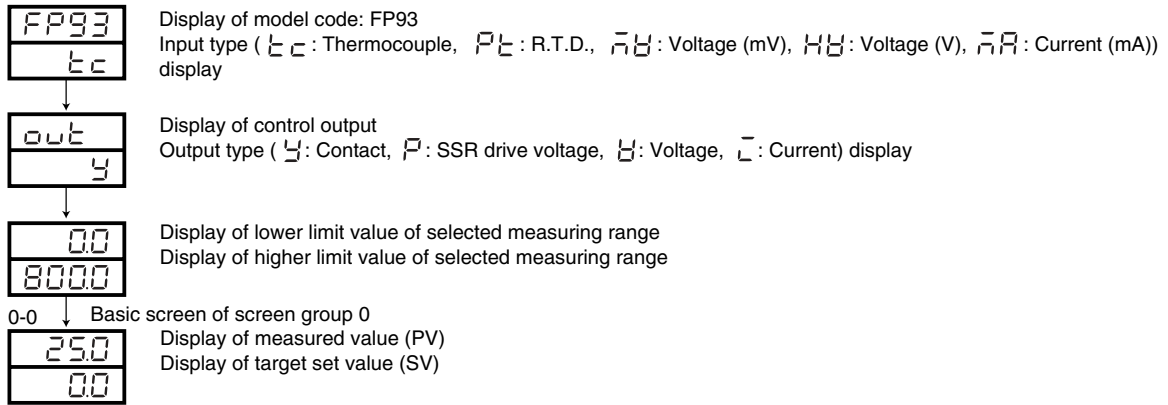

5-3 How to Change Screens

(1) How to Change Screen Groups 0~5

- Pressing the **GRP** key on the basic screen of screen group 0 calls the initial screen of screen group 1.
 - Pressing the **⌚** key on the basic screen of screen group 0 continuously for 3 seconds calls the initial screen of screen group 5.
 - Pressing the **STEP** key on any screen of screen group 1 calls the 2-1 screen of screen group 2.
 - Pressing the **GRP** key on the initial screen of screen group 1 calls the initial screen of screen group 3.
 - Pressing the **GRP** key on any of the screens of screen group 2 calls the initial screen of screen group 1.
 - Pressing the **GRP** key on the initial screen of screen group 3 calls the initial screen of screen group 4.
 - Pressing the **GRP** key on the initial screen of screen group 4 calls the basic screen of screen group 0.
 - Pressing the **GRP** key on the initial screen of screen group 5 calls the basic screen of screen group 0.
 - Pressing the **GRP** key on any screen midway of screen group 0, 1, 3, 4 or 5 calls the initial screen of the screen group.
 - Pressing the **⏪** key on any screen midway of screen group 1, 2, 3, 4 or 5 calls the preceding screen.
- (Nevertheless, to return to the initial screen in screen group 1 or 4, you have to press the **GRP** key or press the **⌚** key continuously to move to the last screen of the group before returning to the initial screen.

① How to move among 0~4 screen groups

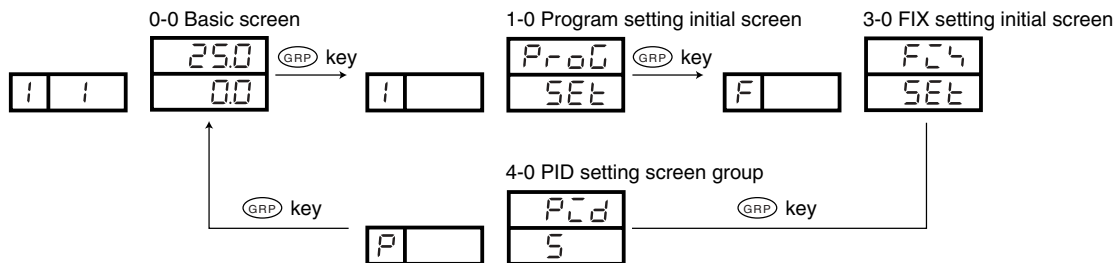

② How to move between screen group 0 and screen group 5

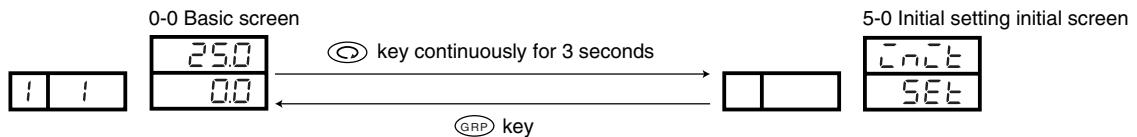

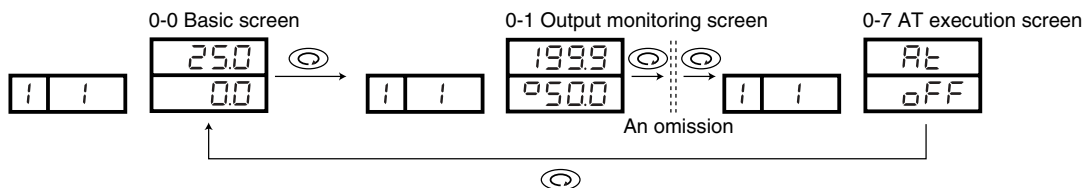

(2) How to Change Screen in Screen Group 0

Every time the **⌚** key is pressed, the next screen is called, and the basic screen is called from the last screen.



(3) How to Change Screen in Screen Group 3

Every time the  key is pressed, the next screen is called, and the basic screen is called from the last screen. Pressing the  key calls the preceding screen.

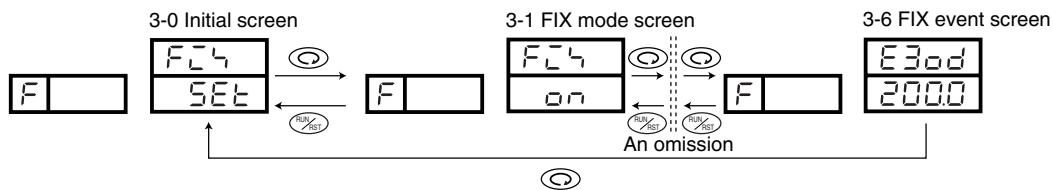

(4) How to Change Set Values (Data)

To change data on a screen which is called by pressing the  key, use the  or  key, and register the changed data by pressing the  key.

5-4. Before Starting Up

To begin with, check the wiring and carry out the following on the respective setting screens. (Factory-set items and items already set by equipment manufacturers need not be set here.)

- (1) Checking Wiring : Check that the wiring to connected terminals is carried out properly. If the power line is erroneously connected to other terminals, it may cause burnout.
- (2) Applying power : Apply operating power. The controller is energized and the data display and other lamps light.
- (3) Setting Measuring Range : Select a code from the list of measuring range codes on the 5-5 Measuring range code setting screen. For current, voltage or mV input, lower/higher limit values and the position of decimal point of the contents of display in response to input signal should be set. (Depending on a selected code, selection on the 5-6, 5-7 and 5-8 is also required.)
- (4) Setting Control Mode : In the case of ON-OFF (two-position) action, call the 4-1 Output proportional band setting screen of screen group 4 and select OFF for P and register it.
- (5) Setting Control Output Characteristic : On the 5-12 Control output characteristics setting screen, select either RA (heating action) or DA (cooling action) for Act according to the purpose of use and register it.
- (6) Setting Other Data : Input necessary items such as program, event action and external input of program control. Record necessary data in "8. Record of Parameter Setting" and input them.
- (7) Note on Initialization upon Change of Data : When a set data on measuring range code, input unit, higher/lower limit value of input scaling, event type, analog output type or the like is changed, related data is initialized and resetting is required.

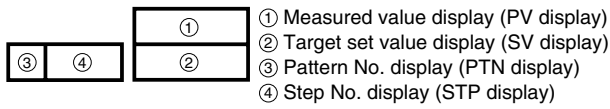

- ① Measured value display (PV display)
- ② Target set value display (SV display)
- ③ Pattern No. display (PTN display)
- ④ Step No. display (STP display)

5-5. Explanation of Screen Group 0 and Setting

0-0 Basic screen

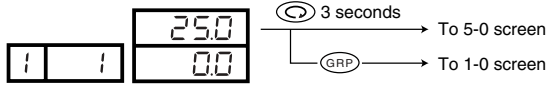

Initial value of SV: 0.0 or 0
 Setting range: Within measuring range (within SV limiter)

PV display : Display of measured value (PV)
 SV display : Display of target set value (SV) and change of setting (in FIX mode)
 PTN display : Display of pattern No. currently in execution.
 STP display : Display of step No. currently in execution.
 When the (PTN) key is pressed in the state of stop (RST), the decimal point of PTN display blinks to enable you to select a start pattern. Upon selection, press the (ENT) key to register. In the event you do not register in 3 minutes, the preceding state returns. When F (FIX) mode has been selected, FIX SV value can be changed by means of the (▲) or (▼) key. When the (F) key is pressed for 3 seconds on this screen, RUN is put into execution.

0-1 Output monitoring screen

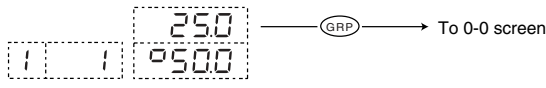

Manual output setting range: 0.0 ~ 100.0%
 Control output value of Output is displayed on the SV display. In automatic operation, the present output value is monitored. In manual operation, a set output value is changed.
 ● How to switch manual to/from auto
 Press the (ENT) key for 3 seconds continuously while RUN is in execution.
 For further details, see 6-3 Setting Output Manually.

0-2 Step remaining time monitoring screen

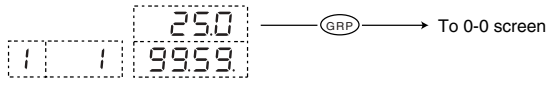

The SV display shows remaining time of the step currently in execution. This is on display only during RUN execution in the PROG mode. If stop (RST) is input through external control input (DI) 1 or in the case of a change to FIX mode through DI, the 0-0 basic screen is returned.

0-3 Monitoring screen for the number of pattern executions



The present number of executions is shown on the SV display. This is on display only when RUN is in execution in the PROG mode. If stop (RST) is input through external control input (DI) 1 or in the case of a change to FIX mode through DI, the 0-0 basic screen is returned.

0-4 PID No. monitoring screen



The number of PID currently in use is shown on SV display. This screen is on display only when RUN is in execution. If stop (RST) is input through external control input (DI) 1, the 0-0 basic screen is returned.

(1) Setting HLD Execution

0-5 HLD execution setting screen

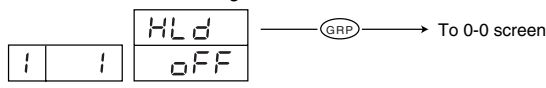

Initial value: OFF
 Setting range: ON/OFF
 HLD is put in execution when ON is selected and selection of OFF releases it. Upon execution of HLD, PROG execution is stopped temporarily. The HLD lamp lights during the execution of HLD. This screen is on display only when RUN is in execution in the PROG mode. If stop (RST) is input through external control input (DI) 1 or in the case of a change to FIX mode through DI, the 0-0 basic screen is returned.
 In case HLD is set for external control input (DI), it functions only as an input status monitoring screen. ADV input is not valid during the execution of HLD.

To 0-6 screen

(2) Setting ADV Execution

0-6 ADV execution setting screen

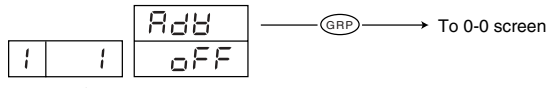

Initial value: OFF
 Setting range: ON/OFF

The selection of ON puts ADV in execution. Upon execution of ADV, the step currently in execution is terminated and forced to move to the next step.

This screen is displayed only when RUN is in execution in the PROG mode. If stop (RST) is input through external control input (DI) 1 or in the case of a change to FIX mode through DI, the 0-0 basic screen is returned

In case ADV is set for external control input (DI), it functions only as an input status monitoring screen. ADV is not valid for 1 second upon changing to a new step and for 2 seconds upon execution of ADV.

(3) Setting Auto Tuning (AT) Execution

0-7 AT execution setting screen

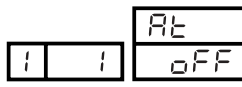

Initial value: OFF
 Setting range: ON/OFF

The selection of ON puts AT in execution and AT is released when OFF is selected. AT execution is possible only when RUN is in execution and the AT lamp blinks during AT execution. The lamp lights during standby.

While AT is in execution, setting and changing are not possible except releasing AT execution, keylock setting, communication mode switching, and RUN/RST, HLD and ADV setting on the basic screen.

For further details, refer to "6-4. Auto Tuning (AT)."

To 0-0 basic screen

5-6. Explanation of Screen Group 1 and Setting

1-0 Initial screen (pattern 1)

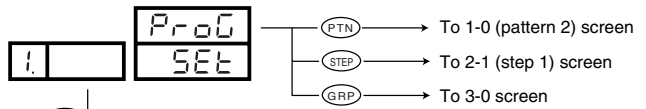

On PTN display, the number (1 ~ 4; decimal point blinking) of a pattern intended to be set is shown.

(1) Setting Start SV

1-1 Start SV setting screen

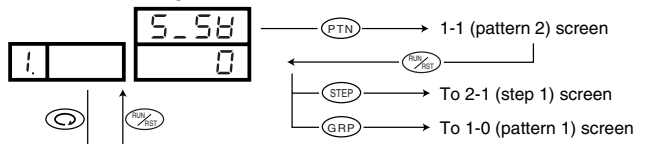

Initial value: 0
 Setting range: Within limiter

Temperature at which program is started is set. A change in SV limiter makes the four decimal place blinking.

(2) Setting End Step

1-2 End step setting screen

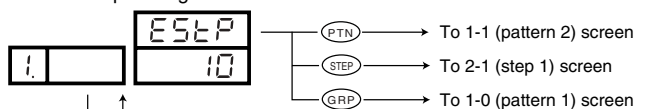

Initial value: 10
 Setting range: 1 ~ Maximum number of steps

The number of steps of a program pattern is set. The number of patterns is set on the 5-1 screen (initial value: 4). The maximum number of steps changes according to the number of patterns.

- (The number of pattern = 1: The maximum number of steps = 40)
- (The number of pattern = 2: The maximum number of steps = 20)
- (The number of pattern = 4: The maximum number of steps = 10)

In case a lower number than the number of step currently in execution is set, the program terminates upon completion of the step currently being executed or moves to the initial step.

To 1-3 screen

(3) Setting Time Signal

1-3 Time signal 1 (TS1) ON step setting screen

Initial value: OFF
Setting range: OFF, 1 ~ End step
A step in which TS1 signal is output is set. This screen is on display when t_{TS1} is set for event or status output. For details about time signal, refer to "6-15 Time Signal." A change of end step makes four decimal places blink if set value of end step < TS1 ON step setting.

1-4 Time signal 1 (TS1) ON time setting screen

Initial value: 00.00
Setting range: 00.00 ~ 99.59
A time from the start of step in which TS1 signal is output to the output of the signal is set. This screen is not displayed when TS1 ON step is OFF.

1-5 Time signal 1 (TS1) OFF step setting screen

Initial value: OFF
Setting range: OFF, 1 ~ End step
A step in which TS1 signal is stopped is set. This screen is not displayed when TS1 ON step is OFF. A change of end step makes four decimal places blink if set value of end step < TS1 OFF step setting.

1-6 Time signal 1 (TS1) OFF time setting screen

Initial value: 00.00
Setting range: 00.00 ~ 99.59
A time from the start of step in which TS1 signal is stopped to the stop of the signal is set. This screen is not displayed when TS1 ON step is OFF.

1-7 Time signal 2 (TS2) ON step setting screen

Initial value: OFF
Setting range: OFF, 1 ~ End step
A step in which TS2 signal is output is set. This screen is on display when t_{TS2} is set for event or status output. For details about time signal, refer to "6-15 Time Signal." A change of end step makes four decimal places blink if set value of end step < TS2 ON step setting.

1-8 Time signal 2 (TS2) ON time setting screen

Initial value: 00.00
Setting range: 00.00 ~ 99.59
A time from the start of step in which TS2 signal is output to the output of the signal is set. This screen is not displayed when TS2 ON step is OFF.

To 1-9 screen

1-9 Time signal 2 (TS2) OFF step setting screen

Initial value: OFF
Setting range: OFF, 1 ~ End step
A step in which TS2 signal is stopped is set. This screen is not displayed when TS1 ON step is OFF. A change of end step makes four decimal places blink if set value of end step < TS1 ON step setting.

1-10 Time signal 2 (TS2) OFF time setting screen

Initial value: 00.00
Setting range: 00.00 ~ 99.59
A time from the start of step in which TS2 signal is stopped to the stop of the signal is set. This screen is not displayed when TS2 OFF step is OFF. For details about time signal, refer to "6-15. Time Signal."

(4) Setting Event Action Point

1-11 Event 1 (EV1) action point setting screen

Initial value:
Higher limit deviation value (Hd) 2000
Lower limit deviation value (Ld) -1999
Outside higher/lower limit deviation values (od) 2000
Within higher/lower limit deviation values (id) 2000
Higher limit absolute value (HA) Higher limit value of measuring range
Lower limit absolute value (LA) Lower limit value of measuring range
Setting range:
Higher limit deviation value or lower limit deviation value 1999 ~ 2000 units
Within or outside higher/lower limit deviations 0 ~ 2000 units
Higher limit absolute value or lower limit absolute value Within measuring range
This screen is displayed when action code Hd ~ LA is set for EV1, and action point of set event in PROG mode is set. When any other code than Hd ~ LA is set, the screen is not displayed.

1-12 Event 2 (EV2) action point setting screen

The same as the 1-11 screen except EV1 changed to EV2.

1-13 Event 3 (EV3) action point setting screen

The same as the 1-11 screen except EV1 changed to EV3.

(5) Setting the Number of Program Executions

1-14 The number of program executions setting screen

Initial value: 1
Setting range: 1 ~ 9999
The number of executions of a presently set pattern is set. In case a lower number than the number of pattern currently being executed is set, the program is terminated upon execution to the end step.

To 1-15 screen

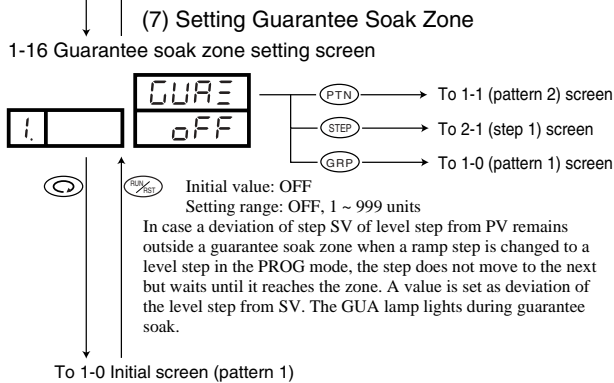
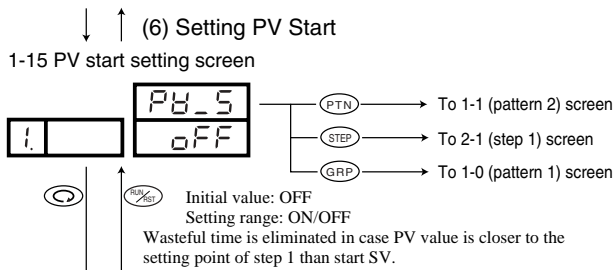

5-7. Explanation of Screen Group 2 and Setting

(1) Setting Step SV

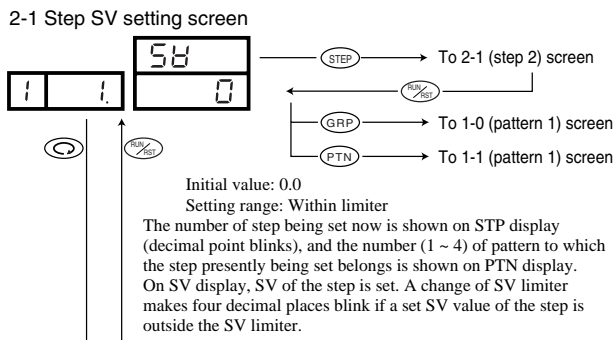

(2) Setting Step Time

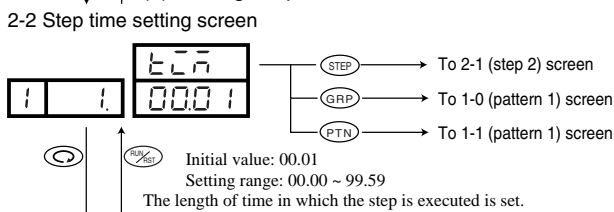

(3) Setting PID No.

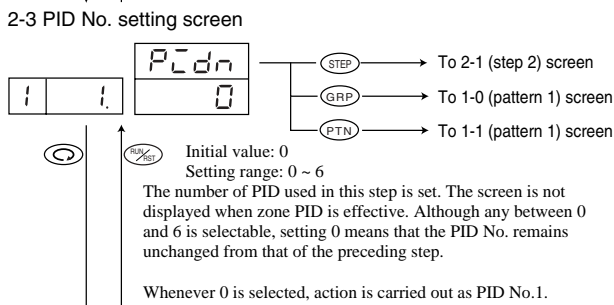

5-8. Explanation of Screen Group 3 and Setting

3-0 Initial screen

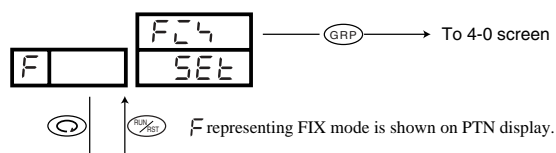

(1) Setting ON/OFF of FIX Mode

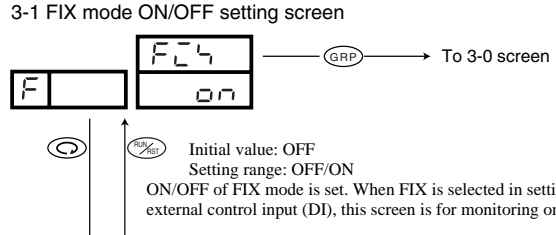

(2) Setting FIX SV Value

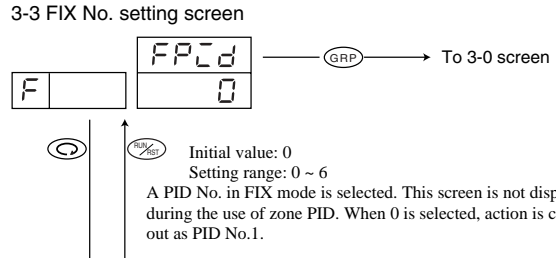
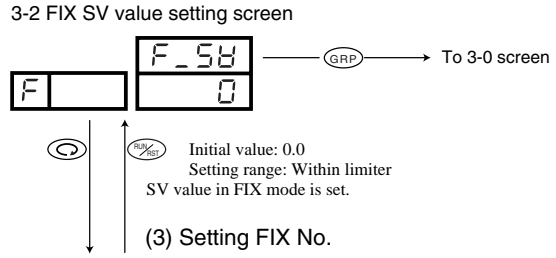

(4) Setting FIX Event Action Point

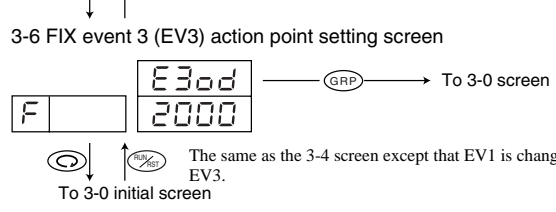
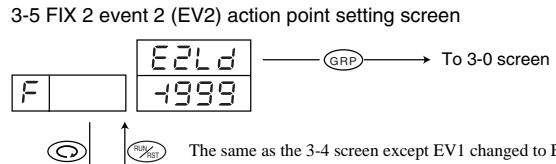
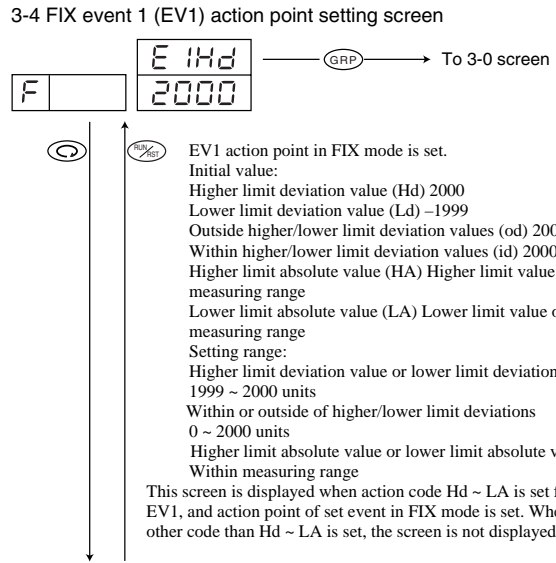

5-9. Explanation of Screen Group 4 and Setting

Setting of PID Nos.1-6

(1) Setting Outputs of PID Nos. 1~6

4-0 Initial screen

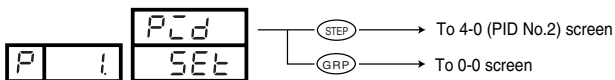

P representing PID is shown on PTN display.
 PID No. (Decimal point also lights) is shown on STP display.

4-1 Output proportional band setting screen

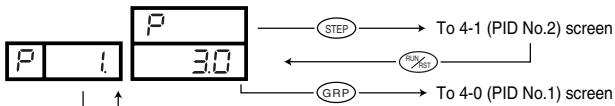

Initial value: 3.0
 Setting range: OFF, 0.1 ~ 999.9%
 To execute auto tuning, basically this setting is not necessary.
 When OFF is selected, ON/OFF (2-position) action is performed.
 For proportional action, refer to "6-5. PID Action."

4-2 Output hysteresis setting screen

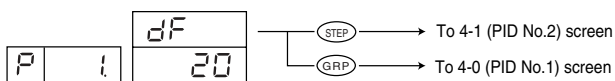

Initial value: 20
 Setting range: 1 ~ 999 units
 "Hysteresis" in ON/OFF action is set. This screen is displayed only when OFF is set for P in setting on 4-1 screen.

4-3 Output integral time setting screen

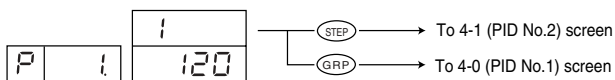

Initial value: 120
 Setting range: OFF, 1 ~ 6000 seconds
 Basically this setting is not necessary when auto tuning is executed.
 For integral time, refer to "6-5. PID Action." This screen is not displayed when P=OFF.

4-4 Output derivative time setting screen

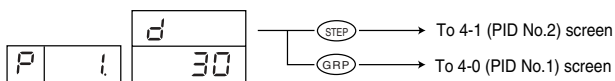

Initial value: 30
 Setting range: OFF, 1 ~ 3600 seconds
 Basically this setting is not necessary when auto tuning is executed.
 For derivative time, refer to "6-5. PID Action." This screen is not displayed when P=OFF.

4-5 Output manual reset setting screen

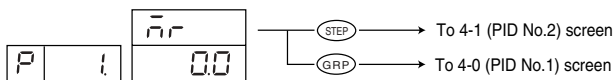

Initial value: 0.0
 Setting range: -50.0 ~ 50.0%
 When I=OFF (P action or PD action), offset correction is carried out. For details, refer to "6-6. Manual Reset." This screen is not displayed when P=OFF.

4-6 Output target value function setting screen

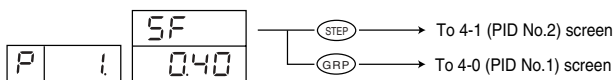

Initial value: 0.40
 Setting range: OFF, 0.01 ~ 1.00
 A value to be used to suppress overshooting or undershooting in expert PID is set. Setting 1.00 for SF makes overshoot minimum, and when SF ≤ 0.10 in the program mode or SF=OFF in the FIX mode, expert PID does not function and ordinary PID action is carried out. This screen is not displayed when P=OFF.

To 4-7 screen

4-7 Lower limit output limiter setting screen

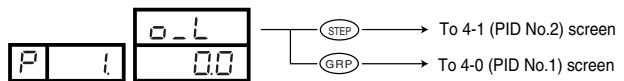

Initial value: 0.0
 Setting range: 0.0 ~ 99.9%
 A lower limit limiter for output is set. For output limiter, refer to "6-7. Output Lower Limit and Higher Limit Setting Limiters."

4-8 Higher limit output limiter setting screen

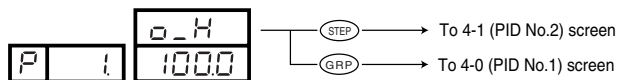

Initial value: 100.0
 Setting range: 0_L+0.1 ~ 100.0%
 A lower limit limiter for output is set.

To the initial screen of the set one of 4-0 PID Nos. 1 ~ 6.

(2) Setting Zone PID

4-10 Initial screen

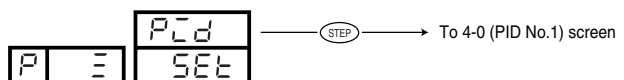

The step number display shows Z (≡) of "zone."

4-11 Zone PID ON/OFF setting screen

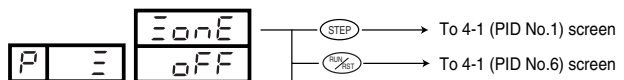

Initial value: OFF
 Setting range: ON/OFF
 ON/OFF of zone PID is set. For zone PID, refer to "6-9. Zone PID."

4-12 Zone 1 SP setting screen

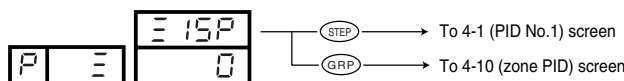

Initial value: 0
 Setting range: Within measuring range
 A zone where PID No.1 is used is set.

4-13 Zone 2 SP setting screen

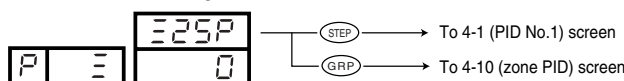

Initial value: 0
 Setting range: Within measuring range
 A zone where PID No.2 is used is set.

4-14 Zone 3 SP setting screen

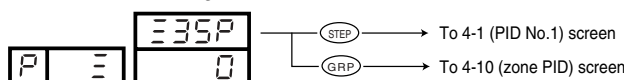

Initial value: 0
 Setting range: Within measuring range
 A zone where PID No.3 is used is set.

4-15 Zone hysteresis setting screen

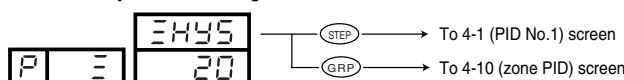

Initial value: 20
 Setting range: 0 ~ 999 units
 A hysteresis (to ensure a set zone value) at the time of a change of PID in the zone PID is set.

To 4-10 Initial screen of zone PID.

5-10. Explanation of Screen Group 5 and Setting

5-0 Initial screen

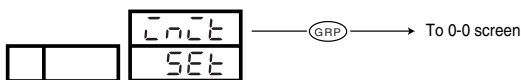

In this screen group, nothing is shown on the PTN and STP displays.

(1) Setting the Number of Patterns

5-1 The number of patterns setting screen

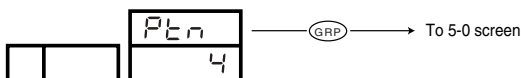

Initial value: 4
Setting range: 1, 2, 4
The number of patters to be used is set. Maximum steps of a pattern changes according to the number of patterns: 40 steps when the number of patterns is 1, 20 when it is 2 and 10 when it is 4. A set number is unable to be changed during RUN in the PROG mode.

(2) Setting Time Unit

5-2 Time unit setting screen

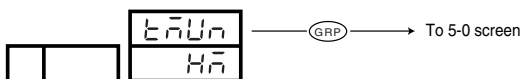

Initial value: Hn
Setting range: Hn (HM)/nS (MS)
A unit of time used in various items, such as step signal and step time, is set.
Hn stands for "~hours~minutes" and nS for "~minutes~seconds."
A set unit is unable to be changed during RUN in the PROG mode.

(3) Setting With/Without Power Failure Compensation

5-3 With/without power failure compensation setting screen

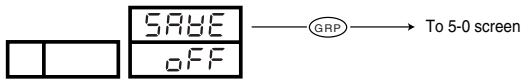

Initial value: OFF
Setting range: ON/OFF
When OFF is set, the instrument starts up in the state of RST in the PROG mode when power is applied again, that is, a state preceding the power failure is not maintained. When ON is selected, the instrument starts up in a state preceding the power failure. (In the FIX mode, a state preceding the power failure is always maintained.)
The following are excluded, however:
• AT in execution.
• A change in the state of DI input (Power supply is interrupted in the state of ON, turned OFF during interruption).
• PID No. where hysteresis of zone PID is involved.

(4) Setting Input Abnormality Mode

5-4 Input abnormality mode setting screen

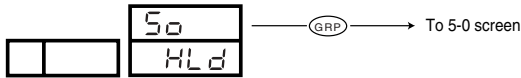

Initial value: Hld
Setting range: Hld (HLD), RUN (RUN), RST (RST)
How to deal with sensor break or scaleover, which may occur in the process of program control, is set.
Hld: The HLD state precedes recovery from scaleover or resetting. Output is fixed to 0%. If the sensor has no problem, the HLD state is released upon applying power again.
RUN: Program action continues until the program ends or reset is input. (Time continuation) Output is fixed to 0%.
RST: Program action is released and the instrument is put in the state of reset.

To 5-5 screen

(5) Setting Measuring Range Code

5-5 Measuring range code setting screen

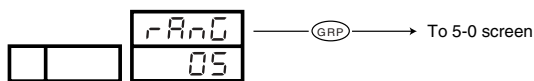

Initial value: 05
Setting range: 01 ~ 92
A measuring range is set. A table of measuring range codes is shown in "5-11. Measuring Range Code Table." A set code is unable to be changed during RUN in the PROG mode.

(6) Setting Input Unit

5-6 Screen for changing set input unit

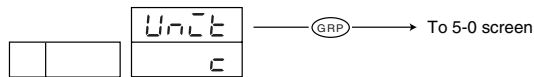

Initial value: C
Setting range: C / F
The unit for sensor input display is selected between C (°C) and F (°F). The screen is not displayed when linear input (mV, V, mA) is selected. A set unit is unable to be changed during RUN in the PROG mode.

(7) Setting Input Scaling

5-7 Input scaling lower limit value setting screen

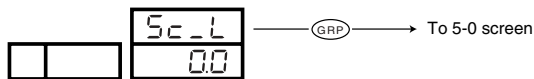

Initial value: 0.0
Setting range: -1999 ~ 9989 units
A lower limit value of scaling for linear input (mV, V, mA) is set. During sensor input, the lower limit of measuring range is displayed and no change is possible. A set value is unable to be changed during RUN in the PROG mode.

5-8 Input scaling higher limit value setting screen

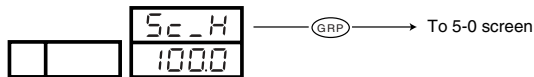

Initial value: 100.0
Setting range: (Input scale) lower limit value + 10 ~ Lower limit value + 5000 units
A higher limit value of scaling for linear input (mV, V, mA) is set. During sensor input, the higher limit of measuring range is displayed and no change is possible. A set value is unable to be changed during RUN in the PROG mode.
Note: If a lower limit value is set so as to have a difference of less than 10 counts or more than 5000 counts from a higher limit value, the higher limit value is forcibly changed to the lower limit value + 10 counts or the lower limit value + 5000.

5-9 Input scaling decimal point position setting

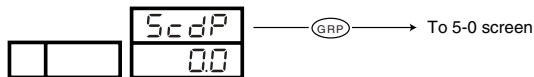

Initial value: 0.0
Setting range: Without decimal point (0) ~ 3 decimal places (0.000)
The position of decimal point for input scaling is set. During sensor input, the screen is for monitoring only and no setting is possible. A set position is unable to be changed during RUN in the PROG mode.

(8) Setting PV Bias

5-10 PV Bias setting screen

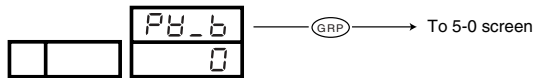

Initial value: 0.0
Setting range: -1999 ~ 2000 units
PV bias is used to correct an error of input from sensor or the like. When a bias is set, control is also carried out with a corrected value.

(9) Setting PV Filter

5-11 PV filter setting screen

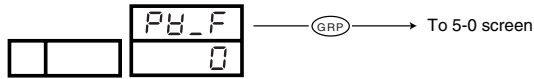

Initial value: 0
Setting range: 0 ~ 100 seconds
In case input changes conspicuously or noise continues, PV filter is used to mitigate such undesirable effect. When 0 second is set, filter does not function.

To 5-12 screen

↓ ↑ (10) Setting Output Control Characteristic
5-12 Output control characteristic setting screen

Initial value: *rA*
Setting range: *rA* (RA), *dA* (DA)
A characteristic of control output is set. RA is for heating and DA cooling.

(11) Setting Proportional Cycle
5-13 Proportional cycle setting screen

Initial value: Y output: 30, P output: 3
Setting range: 1 ~ 120 seconds
Proportional cycling time of control output is set. This screen is not displayed in the case of voltage or current output. For details of proportional cycle, see "6-8. Proportional Cycle Time."

(12) Setting SV Limiter
5-14 SV limiter lower limit value setting screen

Initial value: Lower limit value of measuring range
Setting range: Lower limit value of measuring range ~ Higher limit - 1 count
When a narrower range than the measuring range is used for target value setting, a lower limit value is set. (It prevents erroneous setting in a dangerous range.)

5-15 SV limiter higher limit value setting screen

Initial value: Higher limit value of measuring range
Setting range: *SV_L* + 1 count ~ Higher limit of measuring range
When a wider range than the measuring range is used for target value setting, a higher limit value is set. (It prevents erroneous setting in a dangerous range.)
Note: In SV limiter setting, SV limiter lower limit value < SV limiter higher limit value and the lower limit value is given preference, that is, it is not possible to set a higher value which is less than a lower level + 1 count.

(13) Setting External Control Input
5-16 External control input 2 (DI2) action code setting screen

Initial value: *non*
Setting range: *non* (non), *Hld* (HLD), *Adv* (ADV), *Fix* (FIX), *SPT2* (SPT2), *SPT3* (SPT3)
An action code of external control input 2 (DI2) is set. For details of DI input, see "6-10. External Control Input."
This screen does now show *SPT2*.

Table of External Control Input (DI) Codes

DI code	Description
<i>non</i>	Without DI
<i>Hld</i>	Hold
<i>Adv</i>	Advance
<i>Fix</i>	FIX level
<i>SPT2</i>	Starting pattern No.2 bit
<i>SPT3</i>	Starting pattern No.3 bit

5-17 External control input 3 (DI3) action code setting screen

Initial value: *non*
Setting range: *non* (non), *Hld* (HLD), *Adv* (ADV), *Fix* (FIX), *SPT2* (SPT2)
An action code of external control input 3 (DI3) is set. This screen is not displayed when the external control input 2 (DI2) code is *SPT3*.
This screen does not show *SPT3*.

5-18 External control input 4 (DI4) action code setting screen

Initial value: *non*
Setting range: *non* (non), *Hld* (HLD), *Adv* (ADV), *Fix* (FIX)
An action code of external control input 4 (DI4) is set. This screen is not displayed when the external control input 2 (DI2) code is *SPT3* and when the external control input 3 (DI3) code is *SPT2*.
This screen does not show *SPT2* and *SPT3*.

(14) Setting Events
5-19 Event 1 (EV1) type setting screen

Initial value: *Hd*
Setting range: *non* ~ *Fix*
The type of event to be set as EV1 is selected from the following table.

Table of Event Type Codes

Code	Type of event
<i>non</i>	None
<i>Hd</i>	Higher limit deviation
<i>Ld</i>	Lower limit deviation
<i>od</i>	Outside higher/lower limit deviations
<i>cd</i>	Within higher/lower limit deviations
<i>HA</i>	Higher limit absolute value
<i>LA</i>	Lower limit absolute value
<i>So</i>	Scaleover
<i>Hold</i>	Hold
<i>GuarE</i>	Guarantee soak
<i>tNS1</i>	Time signal 1
<i>tNS2</i>	Time signal 2
<i>run</i>	RUN status
<i>StPS</i>	Step signal
<i>EndS</i>	End signal
<i>Fix</i>	FIX

5-20 Event 1 (EV1) hysteresis setting screen

Initial value: 5
Measuring range: 1 ~ 999 units
Hysteresis is set for EV1. This screen is displayed when an EV1 code is *Hd*, *Ld*, *od*, *cd*, *HA* or *LA*.

5-21 Event 1 (EV1) standby action setting screen

Initial value: 5
Measuring range: 1 ~ 999 units
EV1 standby action type code is selected from the following table. This screen is displayed when an EV1 code is *Hd*, *Ld*, *od*, *cd*, *HA* or *LA*.

Table of Standby Action Codes

Code	Description
1	Without standby function
2	Standby action only when power is applied, or when the state is switched from RST (stop) to RUN (execution)
3	Standby action when power is applied, or when the state is switched from RST (stop) to RUN (execution), or when SV in execution is changed
4	Control mode (without standby)

5-22 Event 2 (EV2) type setting screen

Initial value: *Ld*
Setting range: *non* ~ *Fix*
The same as the 5-19 screen except EV1 changed to EV2.

To 5-18 screen

To 5-23 screen

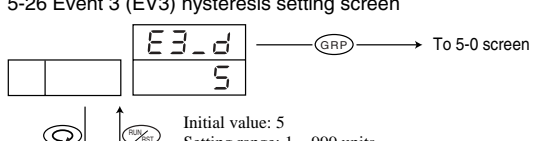
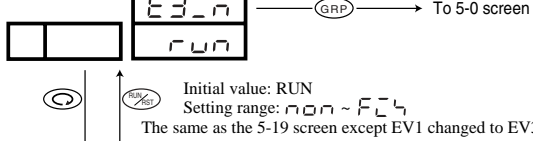
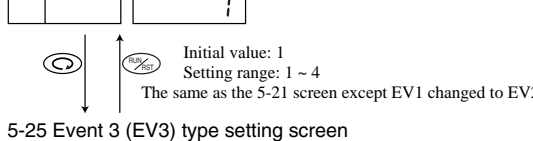
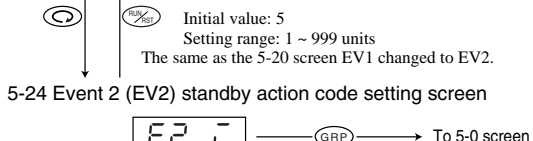
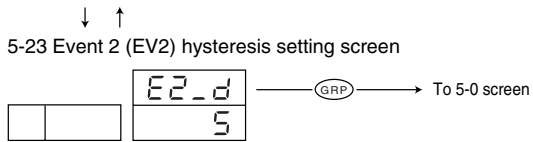

(15) Setting Status Output (DO)

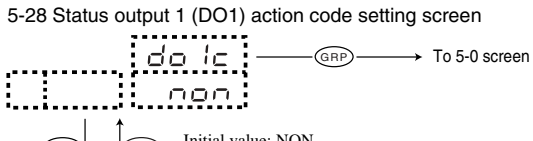

A code to be set as DO1 is selected from the following table:
Table of Status Output Action Type Codes

Code	Description
non	None
So	Scaleover, Hold
HoLd	Hold
GUAR	Guarantee soak
tS1	Time signal 1
tS2	Time signal 2
run	RUN status
StPS	Step signal
EndS	End signal
Fc4	FIX

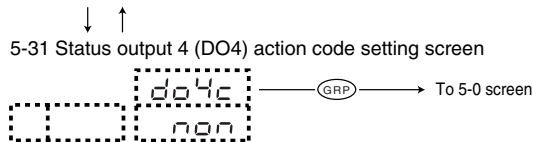
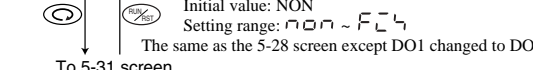
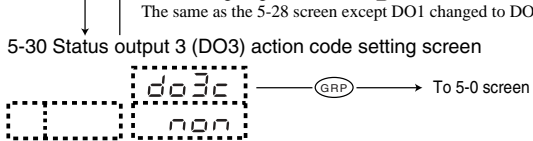
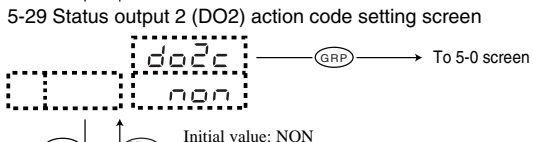

(16) Setting Analog Output

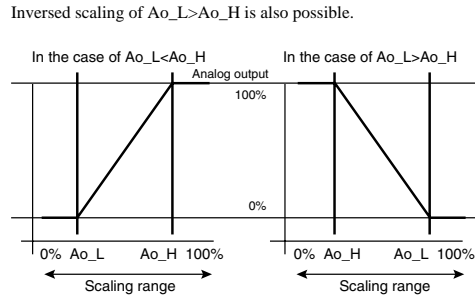
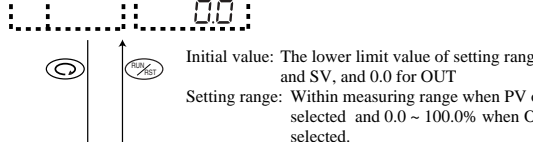
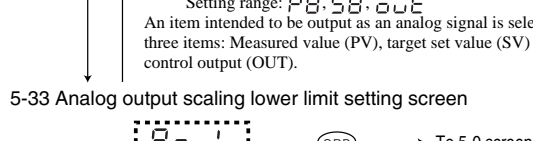
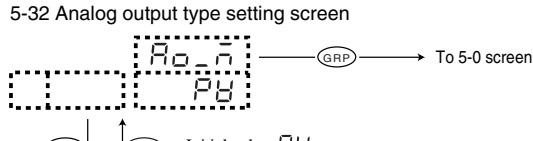

(17) Setting Communication

Note: For communication, refer to the Communication Interface Instruction Manual provided separately.

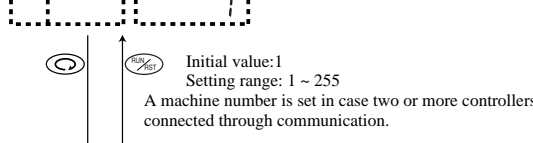
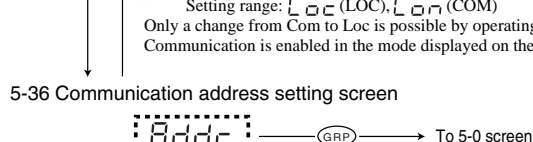
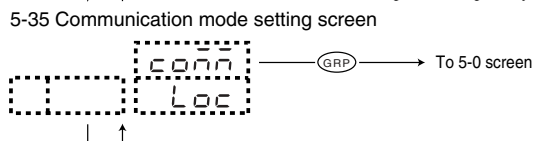

5-37 Communication speed setting screen

Initial value: 1200
Setting range: 1200, 2400, 4800, 9600, 19200 bps
The speed of communication is set.
Note 1: Because of a limited number of digits, 19200 bps is displayed as 192H.
Note 2: Special keys on the communication speed screen: When the (PTN) key and the (STEP) key are pressed simultaneously for 3 seconds on this screen, the present speed is forcibly changed. This interrupts communication and the mode is changed from communication to local. To restart communication, the same speed as that of the host has to be set.

5-38 Communication data format setting screen

Initial value: 7E1
Setting range: 7E1 (7 bits, even parity, stop bit 1) 8n1 (8 bits, non-parity, stop bit 1)
A communication data format is set.

5-39 Start character setting screen

Initial value: Stx
Setting range: Stx, St (STX), Alt (@)
Which of STX and @ is used as the start character of communication format is set.

5-40 BCC operation type setting screen

Initial value: 1
Setting range: 1 ~ 4
An operation type for error detection BCC check is selected from the following table:

Type of Operation	Description
1	Add operation from start character to text end character
2	2's complement after add operation from start character to text end character
3	Exclusive OR operation from 2nd character to text end character
4	Without BCC operation

5-41 Communication delay time setting screen

Initial value: 20
Setting range: 1 ~ 100
Minimum delay time lag from receiving a communication command to transmission is set. Minimum delay time = Set value × 0.512msec

5-42 Communication memory mode setting screen

Initial value: EEP
Setting range: EEP, rA, r-E
Which of EEPROM and RAM data is written in through communication is set.

Type	Writing Process
EEP	All to be written in EEPROM
rA	All to be written in RAM
r-E	FIX SV, OUT and STEP SV to be written in RAM and others in EEPROM

To 5-43 screen

(18) Setting Keylock

5-43 Keylock setting screen

Initial value: OFF
Setting range: OFF, 1, 2, 3
Items which should not be changed are locked. Data are unable to be changed on locked screens. Select OFF to release the lock.

Lock No.	Range to be locked
OFF	Release of lock (All data allowed to be changed.)
1	Keylock of the screen groups 3, 4 and 5 (excluding communication mode and special keys on communication speed screen)
2	Keylock of screen groups 1, 2, 3, 4 and 5 (excluding communication mode and special keys on communication speed screen)
3	Keylock of all screens excluding RUN/RST on the basic screen, communication mode screen and special keys on communication speed screen)

5-11. Measuring Range Codes Table

Select a measuring range from the following table.
Note: A change of a measuring range code will initialize all data related to the measuring range.

Input type	Code	Measuring range			
		BC	BF		
Thermocouple	B *1	01	0 ~ 1800	0 ~ 3300	
	R	02	0 ~ 1700	0 ~ 3100	
	S	03	0 ~ 1700	0 ~ 3100	
	K	04*2	-199.9 ~ 400.0	-300 ~ 750	
		05	0.0 ~ 800.0	0 ~ 1500	
		06	0 ~ 1200	0 ~ 2200	
	E	07	0 ~ 700	0 ~ 1300	
	J	08	0 ~ 600	0 ~ 1100	
	T	09*2	-199.9 ~ 200.0	-300 ~ 400	
	N	10	0 ~ 1300	0 ~ 2300	
	PLII *3	11	0 ~ 1300	0 ~ 2300	
	Wre5-26 *4	12	0 ~ 2300	0 ~ 4200	
	U *5	13*2	-199.9 ~ 200.0	-300 ~ 400	
	L *5	14	0 ~ 600	0 ~ 1100	
Multi-input	R.T.D.	Pt	31	-200 ~ 600	-300 ~ 1100
			32	-100.0 ~ 100.0	-150.0 ~ 200.0
			33	-50.0 ~ 50.0	-50.0 ~ 120.0
			34	0.0 ~ 200.0	0.0 ~ 400.0
	JPt	35	-200 ~ 500	-300 ~ 1000	
		36	-100.0 ~ 100.0	-150.0 ~ 200.0	
		37	-50.0 ~ 50.0	-50.0 ~ 120.0	
		38	0.0 ~ 200.0	0.0 ~ 400.0	
mV	-10~10mV	71	Scaling possible. Setting range: -1999 ~ 9999 Span: 10 ~ 5000 Decimal point position: 0.000 ~ None		
	0~10mV	72			
	0~20mV	73			
	0~50mV	74			
	10~50mV	75			
	0~100mV	76			
V	-1~1V	81	Scaling possible. Setting range: -1999 ~ 9999 Span: 10 ~ 5000 Decimal point position: 0.000 ~ None		
	0~1V	82			
	0~2V	83			
	0~5V	84			
	1~5V	85			
	0~10V	86			
mA	0~20mA	91	Scaling possible. Setting range: -1999 ~ 9999 Span: 10 ~ 5000 Decimal point position: 0.000 ~ None		
	4~20mA	92			

Thermocouple B, R, S, K, E, J, T, N: JIS/IEC
R.T.D Pt100: JIS/IEC; JPt100: Former JIS

- *1 Thermocouple B: Accuracy guarantee not applicable to 400BC(725BF) and below.
- *2 Thermocouple K, T, U: Accuracy of those whose readings are below -100BC is ±0.7% FS.
- *3 Thermocouple PLII: Platinum
- *4 Thermocouple Wre5-26: A product of Hoskins
- *5 Thermocouple U, L: DIN 43710

● When not designated, factory-set measuring range is K thermocouple (0.0 ~ 800.0BC).

6. Operation and Functions

6-1. Using FIX Mode

FIX: Adjustment function without using the program function.

- ① Pressing the \blacktriangle or \blacktriangledown key on the 3-1 FIX ON/OFF screen turns OFF shown on the target value (SV) display to ON and the decimal point of the rightmost digit blinks. Then, press the ENT key, and the decimal point stops blinking to register the selection. (When OFF is set for FIX on this screen, the program mode turns ON.)
- ② Pressing the ENT key calls the next setting screen. Set a necessary item, if any.
- ③ When the display returns to the basic screen upon completion of setting, F is shown on the pattern number display and the FIX mode is ON.

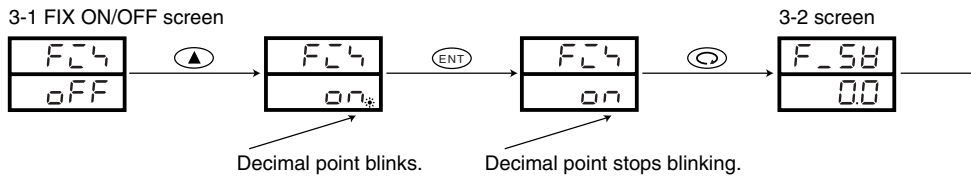

6-2. Setting Target Value (SV) (FIX Mode)

- ① Setting on the basic screen
When the \blacktriangle or the \blacktriangledown key is pressed on the 0-0 basic screen, the decimal point of the rightmost digit blinks and the numerical value changes. The value keeps changing while either of the keys is being pressed. Once an intended value is reached, press the ENT key to register it. The registration of the data stops the blink of the decimal point.
 - ② Setting on the SV setting screen
When the \blacktriangle or the \blacktriangledown key is pressed on the 3-2 FIX SV setting screen, the decimal point of the rightmost digit blinks and the numerical value changes. The value keeps changing while either of the keys is being pressed. Once an intended value is reached, press the ENT key to register it. The registration of the data stops the blink of the decimal point.
- * In the program mode, SV value is unable to be changed on the basic screen.
* In the program mode, the 1-1 start SV setting screen and the 2-1 step SV setting screen should be used to set an SV.
* No target value can be changed while auto tuning (AT) is in execution. It should be set after releasing AT.

Example: Setting target value at 100°C

0-0 Basic screen

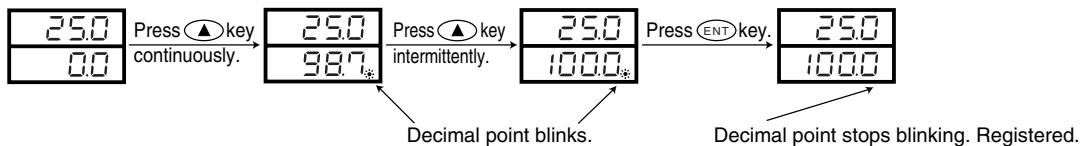

3-2 FIX SV setting screen

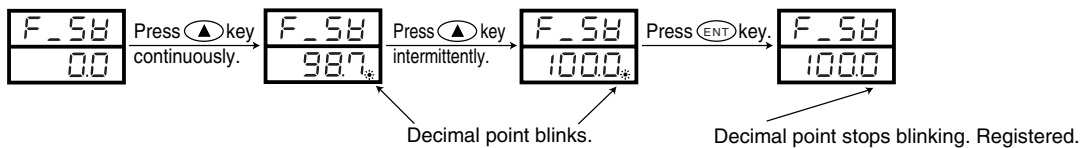

6-3. Setting Output Manually

For switching between auto and manual, press the ENT key continuously for 3 seconds (in the state of RUN) on the output monitoring screen.

During manual output, the MAN lamp lights and it goes out when automatic output begins.

To set a target value, press the \blacktriangle or \blacktriangledown key on the output monitoring screen. When the target value is reached, the setting completes. To release it, press the ENT key again for 3 seconds continuously, and automatic output is resumed.

* Changing to manual output is not possible while auto tuning is in execution.

- ① 100% output is shown as 0.999 and the decimal point of $0.$ blinks.
- ② When OFF is set for proportional band (P) in the case of contact output or SSR drive voltage output, the value of output is either 0.0% or 100.0%.
- ③ When OFF is set for proportional band (P) in the case of voltage output or current output, the output value becomes the lower or higher limit value of a set output limiter.

0-1 Output monitoring screen

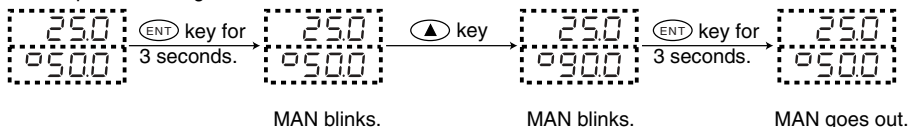

④ Supplementary Explanation of Monitoring Screen

The output monitoring screen (OUT) and automatic output/manual output:

- 1) When auto is changed to manual, output is in balanceless action and an output value immediately before the change is displayed.
When manual is changed to auto, output is in bumpless action if it is bumpless. If it is outside the proportional band, however, the output is not in bumpless action.
- 2) In case power supply was turned OFF and power is applied again, control output is in the mode (either manual or auto) which was ON at the time of interruption of power supply.

NOTE: Even in the manual mode, it is possible to call another screen but it should be noted that control output is in the manual state. Blinking of the MAN action LED shows that the manual mode is ON.

6.4. Auto Tuning (AT)

This is the function to automatically calculate and set P.I.D. values, i.e., parameters of PID control. The time required for calculation depends on the details of control.

① Execution of AT

Pressing the \blacktriangle key on the AT execution setting screen changes OFF shown on the target set value (SV) display to ON and the decimal point on the rightmost digit blinks. Upon pressing the ENT key, the decimal point stops blinking and AT action begins. When the target set value stays in the inclined portions (portions indicated by the arrows of the action display), AT is in the state of standby (the AT lamp lights), and AT is executed while the target set value stays in the level portion (the AT lamp blinks).

While AT is in execution, the ON/OFF action of output is repeated several times in accordance with rise and fall of the measured value from the target value as the border and PID values are stored in an internal memory. Immediately when they are stored, control using these PID values begins and AT action ends. Then, the target set value display shows OFF and the AT lamp goes out. (In case there is AT still to be executed, it is put in the state of standby.)

0-7 AT execution setting screen

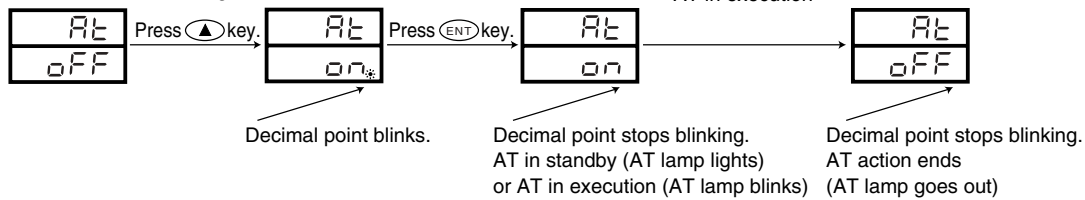

② Release of AT in the Middle

To release AT in the middle, select OFF on the AT execution setting screen by the use of \blacktriangledown key and press the ENT key.

NOTE: In case AT is released in the middle, PID values are not changed.

③ Reasons Why AT Does Not Function

- 1) Control output is in manual mode.
- 2) The proportional band (P) of control output is OFF.
- 3) PV value (measured value) is in the state of scaleover.
- 4) On the keylock screen, No. 3 is selected. (AT is executed when it is turned ON before keylock setting.)
- 5) AT is suspended (RST).

④ If the following conditions arise while AT is in execution, AT is released:

- 1) Output is at 0% or 100% continuously for 200 minutes.
- 2) PV value gets scaleover.
- 3) RST input is received.
- 4) AT is terminated by key operation or through communication.
- 5) AT of PID No. 1 through No. 6 (No. 3 in the case of zone) has completed.

6-5. PID Action

① P (Proportional action)

The ratio (%) of a range in which control output changes relatively to a measuring range is set. Output increases or decreases in proportion to difference between PV value and SV value. The narrower the proportional band, the larger a change in output, i.e., the stronger the proportional action. Nonetheless, an excessively narrow proportional band causes control to vibrate, resulting in control similar to ON-OFF action.

② I (Integral time)

This is the function to correct an offset (constant deviation) produced in proportional band. The longer the integral time, the weaker the correcting action, that is, reducing the integral time strengthens the correcting action but it may cause undulation of control results due to integral hunting.

③ D (Derivative time)

A change in control output is estimated and overshooting is suppressed to improve the stability of control. A longer derivative time strengthens derivative action but it may cause control results to vibrate.

6-6. Manual Reset

In PID action, an offset is corrected automatically by I, i.e., integration. When OFF is set for I, however, this correction is not carried out and so output is increased or decreased manually for correction. This method is called manual reset.

6-7. Output Lower Limit and Higher Limit Setting Limiters

- ① Output limiter means to limit a minimum or maximum value of control output and this function is effective in securing the lowest temperature or suppressing overshooting of control.
- ② Output limiter gives preference to a lower limit value. When a larger lower limit value than a higher limit value is set, the higher limit value is forced to become the lower limit value +0.1%. In other words, it is not possible to set a higher limit value which is less than a lower limit +0.1%.

6-8. Proportional Cycle Time

It can be set within a range from 1 to 120 seconds in the case of contact output or SSR drive voltage output. Proportional cycle time is ON time + OFF time within a proportional band.

6-9. Zone PID

The PID control of this instrument allows you to select and set the zone method. In the zone PID control, a measuring range is divided into three types maximum, and control is carried out with PID No. which is selected automatically from an SV value set for each step. Its basic action is: PID No. changes when control output becomes larger than an SP value or smaller than a zone hysteresis. An example of its action is diagramed below.

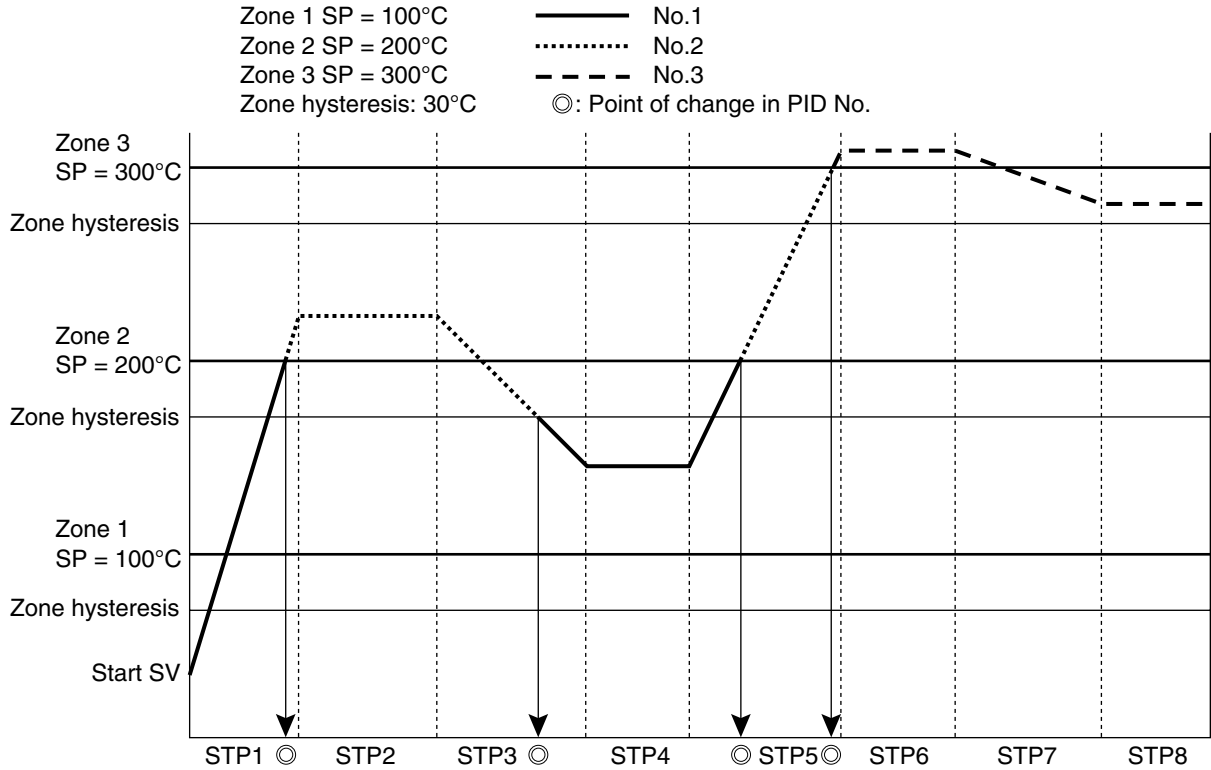

When above diagram shows SV as: Below 200°C → Action with PID No. 1
 200°C ~ 300°C → Action with PID No. 2
 Above 300°C → Action with PID No. 3

When the setting of zone SP is changed as follows:
 Zone 3 SP: 100°C Below 200°C → Action with PID No. 3
 Zone 1 SP: 200°C 200°C ~ 300°C → Action with PID No. 1
 Zone 2 SP: 300°C Above 300°C → Action with PID No. 2

- * When the same zone SP value is set, the lowest number is used preferentially.
- * Even when a zone SP value in action is changed within a zone hysteresis, PID No. is not changed as long as output remains within the hysteresis.

6-10. External Control Input (DI)

The instrument has four DIs. DI is caused to function when any other item than non is set on the setting screen and external terminals are shorted. Action caused by each setting is described below:

- ① RUN/RST
 Switching between RUN and RST. As this is assigned to DI1 fixedly, the setting is unable to be changed. Being edge input, RUN and RST are switched by shorting across terminals 1 and 2.
- ② ADV
 As on the 0-6 ADV execution screen, when executed, the present step comes to an end and is forced to proceed to the next step. Being edge input, ADV is executed every shorting across terminals.
- ③ HLD
 As on the 0-5 HLD execution screen, when executed, the present step time is temporarily suspended and SV is fixed. Being level input, shorting across terminal puts HLD in execution and opening releases it. A change in step time, step SV, time signal ON/OFF time, etc. does not take effect until HLD is released.
- ④ FIX
 As on the 3-1 FIX mode ON/OFF setting screen, when executed, the FIX mode turns ON. Being level input, shorting across terminals turns the FIX mode ON and opening releases it.
- ⑤ SPT3
 A pattern No. at the start of program action is selected by 3 bits of DI2~DI4.
- ⑥ SPT2
 A pattern No. at the start of program action is selected by 2 bits of DI3 and DI4. Being level input, shorting across terminals produces "1" and opening "0". Since the time for removing chattering of level input is 125msec, edge input action need to remain ON for 125msec or longer. If a number exceeding the number of patterns is input, a maximum number of patterns allowed to be set can be set. For example: Where the number of patterns = 2 and DI input is 011, the number of start pattern is 2.

	DI4, 3, 2		DI4, 3	
S	0 0 0	Start with pattern 1	0 0	S
P	0 0 1	Start with pattern 1	0 1	P
T	0 1 0	Start with pattern 2	1 0	T
	0 1 1	Start with pattern 3	1 1	
	1 0 0	Start with pattern 4	Not possible	
3	1 0 1	Start with pattern 4	Not possible	2
	1 1 1	Start with pattern 4	Not possible	

6-11. Events

① Deviation Alarm

An alarm action point is set by a deviation of measured value (PV) from target set value (SV).

For instance, to activate an alarm when measured value (PV) reaches 30°C against SV value at 20°C, higher limit deviation alarm is set at 10°C. To activate alarm when measured value (PV) lowers below 30°C in the case of an SV value at 100°C, lower limit deviation alarm is set at -70°C. This function is convenient for an alarm action point to follow deviations from target set value. The set range is -1999 ~ 2000 units.

② Absolute Value Alarm

An alarm point is set by an absolute value.

For instance, to activate an alarm when measured value exceeds 50°C, higher absolute value alarm is set at 50°C. To activate an alarm when measured value lowers below 20°C, lower absolute value alarm is set at 20°C. Setting of higher or lower absolute value alarm is possible as long as it is within the measuring range.

③ Standby Action

In case 2 or 3 is set for event standby action, there is no event output upon applying power (or changing set value, or switching stop (RST) to execution (RUN)) even when measured value is within an event action area (an ON area). Event is output when it reaches the event action area again after it gets out of the event action area (gets in an OFF area).

④ Non-standby Action

In case event standby action is set for 1 and 4, an alarm is output when measured value gets in an action area upon applying power (or changing target set value).

⑤ Control Mode (4 is set for standby action)

No event is output at the time of scaleover. The same applies to event standby.

6-12. Setting Event Standby Action

On 5-21 Event 1 standby action code setting screen

① When event output is used as an alarm, select from 1, 2 and 3 of the standby action code table.

② When event output is used for control, set 4 (control mode). In case 4 is selected, however, event output turns OFF at the time of input abnormality.

③ When 2 is selected, standby action functions only when power is applied.

④ When 3 is selected, standby action functions when power is applied and when SV in execution is changed.

⑤ When changed to 1 or 4 while standby action is going on, the standby action is released immediately.

⑥ Even when 2 or 3 is selected as standby action, it has no effect if PV value is outside the ON area of event action when power is applied or SV is changed.

6-13. Diagrams of Alarm Actions Selectable as Event

Diagrams of alarm actions to be selected for event 1~3 are shown below:

△ : SV value ▲ : Set value of alarm action point

HLD : Higher limit deviation alarm

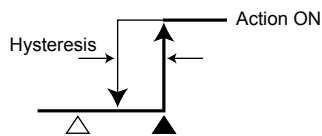

Ld : Lower limit deviation alarm

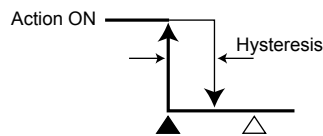

HRA : Higher limit absolute value alarm

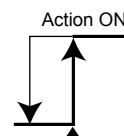

o d : Outside higher/lower limit deviations alarm

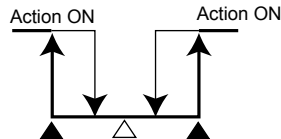

LD : Inside higher/lower limit deviations alarm

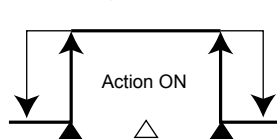

LA : Lower limit absolute value alarm

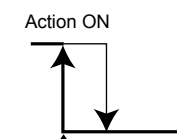

6-14. Event and Status Output Actions

The following nine items can be set for status output of "5-28, 5-29, 5-30 and 5-31" as well as events:

So Scaleover : To be output when measured value (PV) gets 10% above or below higher/lower limits of measuring range. (See the diagram on the right.)

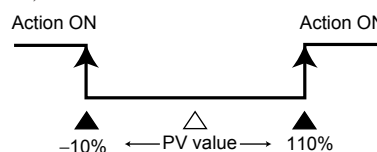

Hold Hold : To be output while HLD is set on DI input and 0-5 HLD execution setting and in communication in the PROG mode.

GUAR Guarantee soak : To be output while the state of guarantee remains in the PROG mode.

Time signal 1 : To be output in the ON/OFF condition set in the time signal 1 setting (1-3, 1-4, 1-5 and 1-6) in the PROG mode. For details, see 6-15.

Time signal 2 : To be output in the ON/OFF condition set in the time signal 2 setting (1-7, 1-8, 1-9 and 1-10) in the PROG mode. For details, see 6-15.

RUN RUN status : To be output while RUN action is in execution.

Step signal Step signal : To be output for one second when a step proceeds to another in the PROG mode.

End signal End signal : To be output for one second when the last step ends in the PROG mode.

FIX FIX : To be output while RUN action is in execution in the FIX mode.

6-15. Time Signal

Time signal: Event output and status output can be produced for a designated period of time. Two points per pattern are equipped and ON step, OFF step, ON time and OFF time can be set individually.

① Time signal functions under the following conditions:

- 1) 𐄂𐄂𐄂 1 or 𐄂𐄂𐄂2 is set as status output of event output.
- 2) OFF is not selected in Time signal ON step setting.
- 3) ON time is set within the end step.
- 4) In the total length of time elapsed since the start of program, ON time ≤ OFF time.
 - In the case of ON step = OFF step and ON time = OFF time, time signal turns ON for one second.
 - In the case of ON step < OFF step and ON time = OFF time in the total length of time elapsed since the start of program, time signal turns ON for one second.

(Example of setting: 1 step 10 minutes, ON step = 1, ON time 15 minutes, OFF step = 2 and OFF time 5 minutes)

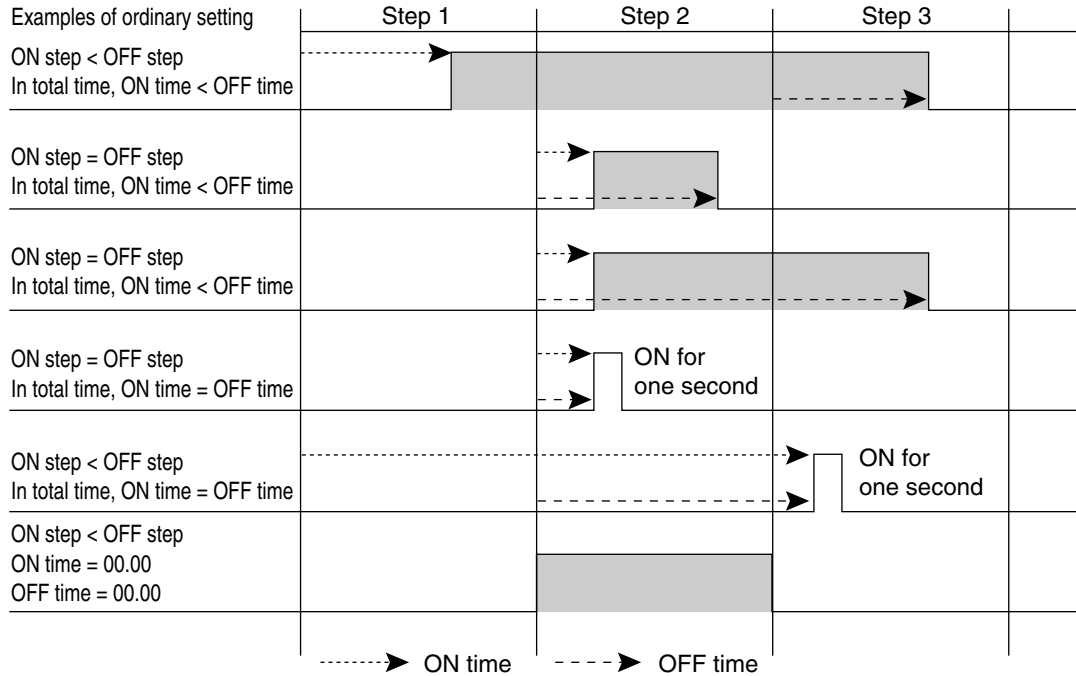

* When a time signal-related parameter is changed during Hold (HLD), the change is not reflected until HLD is released.

② Reasons why time signal does not function (always OFF) (Time signal does not function in the following cases):

- 1) 𐄂𐄂𐄂 1 or 𐄂𐄂𐄂2 is not set as status output of event output (including the case where these options are not added).
- 2) OFF is selected as Time signal ON step setting.
- 3) ON time exceeds the end step.
- 4) In the total length of time elapsed since the start of program, ON time > OFF time is set.

③ Other Matters related to Setting

- 1) The time of time signal is stopped during HLD and guarantee soak.
- 2) In case ON step and ON time are set and OFF step is OFF, once time signal turns ON, the end step also turns ON. (When one or more program executions are set, both remain ON until they are completed.)
- 3) In case OFF time is set beyond the end step, the end step is forcibly turned OFF. When ON step is the first step and 00:00 is set for ON time, it does not turn OFF.
- 4) In case ON time equals step time, it turns ON at the start of the next step.

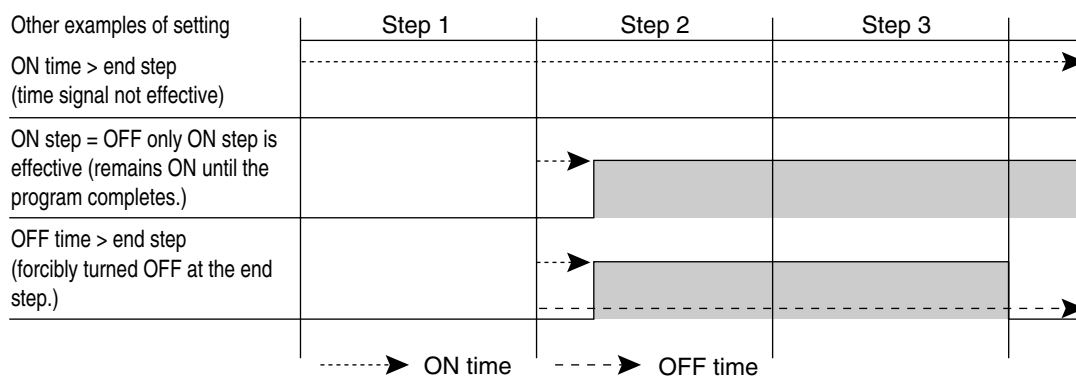

5) When TS is assigned to a step of which the step time is 0, the action is the same as TS is assigned to the next step.

6-16. Status (DO) Output

This instrument has four status output as optional function (open collector output) points.

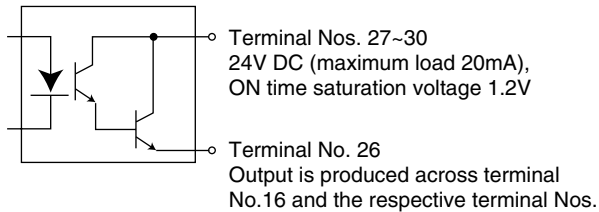

6-17. Auto Return Function

Should there be no key operation for 3 minutes on each screen except the monitoring screens (adjustment output, remaining time of step, the number of pattern executions, PID No.), the display returns automatically to the 0-0 basic screen of screen group 0 (auto return).

6-18. Notes on RAM as Communication Memory Mode

In case RAM is selected on the 5-42 communication memory mode, all set data are written in RAM. Care should be taken as this causes nonconformity of set data in a pattern like the following:

On the assumption that input range is 05 (K 0.0~800.0°C),

- ① An event code is changed from higher limit deviation value to higher limit absolute value through communication (this change is recorded in RAM).
- ② Communication mode is changed from COM to LOC.
- ③ Event action point setting is changed from 800.0 to 700.0 by key operation. (Being in LOC mode, this change is recorded in EEPROM).
- ④ Power supply is interrupted and power is applied again.
- ⑤ The event code recorded in RAM is cleared and higher limit deviation value is read from EEPROM.
- ⑥ Since the event action point set as 700.0 has been written in EEPROM, 700.0 is read.
- ⑦ Consequently, although the setting range of higher limit deviation value is actually -1999~2000 units, an impossible value of 7000 units is set.

To ensure proper use of the instrument, correct data must be set again.

7. Error Codes, Causes and Remedies

Screen display	Problem	Cause	Remedy
HHHH (HHHH)	Higher limit side scaleover	<ol style="list-style-type: none"> ① Break of thermocouple input wiring ② Break of R.T.D. input A wiring ③ Input measured value exceeded higher limit of measuring range by more than 10%. 	<ol style="list-style-type: none"> ① Check thermocouple input wiring. If wiring has no problem, check and replace thermocouple. ② Check wire connection to R.T.D. terminal A. If wiring has no problem, replace R.T.D. ③ For voltage or current input, check the transmitting unit of measured values. Check if set code of measuring range is the same as that of input signal.
LLLL (LLLL)	Lower limit side scaleover	<ol style="list-style-type: none"> ① Problem with wiring connection for input signal ② Input measured value fell from lower limit of measuring range by 10% ③ Nonconformity of input range with input signal 	<ol style="list-style-type: none"> ① Check wire connection for input signal. ② Check wiring of inversed polarity or break of wiring for measured value input. ③ Check input range and input signal.
b --- (b---	Break of R.T.D. input wiring	<ol style="list-style-type: none"> ① Break of B ② More than one break of A, B and B 	Check R.T.D. input terminals A, A and B for breaks. If wiring has no problem, check and replace R.T.D.
CJHH (CJHH)	Higher limit side scaleover of cold junction (CJ) of thermocouple input	Ambient temperature of FP93 has exceeded 80°C.	<ol style="list-style-type: none"> ① Reduce ambient temperature to the level provided in the environment conditions. ② In case ambient temperature has not exceeded 80°C, examine the instrument.
CJLL (CJLL)	Lower limit side scaleover of cold junction (CJ) of thermocouple input	Ambient temperature of instrument has fallen to -20°C or lower.	<ol style="list-style-type: none"> ① Raise ambient temperature to the level provided in the environment conditions. ② In case ambient temperature has not fallen to -20°C, examine the instrument.

Note: When you find something wrong with the instrument, please re-read the instruction manual and examine the instrument again. For any problem with the product or further information, please contact our sales agent.

8. Record of Parameter Setting

(For convenience sake, recording set values and selected items is recommended.) The initial values are of Code 05 (K).

Screen No.	Parameter (Item)/Screen	Initial value	Setting/Selection	Remarks
0-0	Basic screen	0 (0)	0	
0-1	Output monitor			
0-2	Step remaining time			
0-3	Pattern execution number monitor			
0-4	PID No. monitor			
0-5	HLD execution setting	Hld. (HLb)	oFF	
0-6	ADV execution setting	Adv. (Adb)	oFF	
0-7	AT execution setting	At. (At)	oFF	
1-0	Initial screen	ProG. (PrOG)	SEt	
1-1	Start SV	S_SV. (S_Sb)	0	
1-2	End step	EStP. (EStP)	10	
1-3	TS1 ON step assignment	t1oS. (t1oS)	oFF	
1-4	TS1 ON time	t1Ot. (t1Ot)	0000	
1-5	TS1 OFF step assignment	t1FS. (t1FS)	oFF	
1-6	TS1 OFF time	t1Ft. (t1Ft)	0000	
1-7	TS2 ON step assignment	t2oS. (t2oS)	oFF	
1-8	TS2 ON time	t2Ot. (t2Ot)	0000	
1-9	TS2 OFF step assignment	t2FS. (t2FS)	oFF	
1-10	TS2 OFF time	t2Ft. (t2Ft)	0000	
1-11	EV1 level value ★**includes action type.	E1**. (E1**)	Hd: 2000unit Ld: -1999unit od: 2000unit	
1-12	EV2 level value ★**includes action type.	E2**. (E2**)	id: 2000unit	
1-13	EV3 level value ★**includes action type.	E3**. (E3**)	HA: Higher limit of measuring range LA: Lower limit of measuring range	
1-14	Pattern execution number	Pcnt. (Pcnt)	1	
1-15	PV start	PV_S. (PV_S)	oFF	
1-16	Guarantee soak zone	GUAZ. (GUAZ)	oFF	
2-1	Step SV	SV. (Sb)	0	
2-2	Step time	tim. (tā)	0001	
2-3	PID No.	Pidn. (PIdn)	0	
3-0	Initial screen	FIX. (Fcy)	SEt	
3-1	FIX ON/OFF	FIX. (Fcy)	oFF	
3-2	FIX SV value setting	F_SV. (F_Sb)	0	
3-3	FIX PID No. setting	FPid. (FPId)	0	
3-4	EV1 level value ★**includes action type.	E1**. (E1**)	Hd: 2000unit Ld: -1999unit od: 2000unit	
3-5	EV2 level value ★**includes action type.	E2**. (E2**)	id: 2000unit	
3-6	EV3 level value ★**includes action type.	E3**. (E3**)	HA: Higher limit of measuring range LA: Lower limit of measuring range	
PID No. 1				
4-0	Initial screen	Pid. (PId)	SEt	
4-1	PID P	P. (P)	30	
4-2	PID hysteresis	dF. (dF)	20unit	
4-3	PID I	I. (I)	120	
4-4	PID D	d. (d)	30	
4-5	PID MR	mr. (āc)	00	
4-6	PID SF	SF. (SF)	0.40	
4-7	PID lower limit	o_L. (o_L)	00	
4-8	PID higher limit	o_H. (o_H)	1000	

Screen No.	Parameter (Item)/Screen		Initial value	Setting/Selection	Remarks
PID No. 2					
4-0	Initial screen	Pid. (P _{id})	SEt		
4-1	PID P	P. (P)	30		
4-2	PID hysteresis	dF. (dF)	20unit		
4-3	PID I	I. (I)	120		
4-4	PID D	d. (d)	30		
4-5	PID MR	mr. (mr)	00		
4-6	PID SF	SF. (SF)	0.40		
4-7	PID lower limit	o_L. (o_L)	00		
4-8	PID higher limit	o_H. (o_H)	1000		
PID No. 3					
4-0	Initial screen	Pid. (P _{id})	SEt		
4-1	PID P	P. (P)	30		
4-2	PID hysteresis	dF. (dF)	20unit		
4-3	PID I	I. (I)	120		
4-4	PID D	d. (d)	30		
4-5	PID MR	mr. (mr)	00		
4-6	PID SF	SF. (SF)	0.40		
4-7	PID lower limit	o_L. (o_L)	00		
4-8	PID higher limit	o_H. (o_H)	1000		
PID No. 4					
4-0	Initial screen	Pid. (P _{id})	SEt		
4-1	PID P	P. (P)	30		
4-2	PID hysteresis	dF. (dF)	20unit		
4-3	PID I	I. (I)	120		
4-4	PID D	d. (d)	30		
4-5	PID MR	mr. (mr)	00		
4-6	PID SF	SF. (SF)	0.40		
4-7	PID lower limit	o_L. (o_L)	00		
4-8	PID higher limit	o_H. (o_H)	1000		
PID No. 5					
4-0	Initial screen	Pid. (P _{id})	SEt		
4-1	PID P	P. (P)	30		
4-2	PID hysteresis	dF. (dF)	20unit		
4-3	PID I	I. (I)	120		
4-4	PID D	d. (d)	30		
4-5	PID MR	mr. (mr)	00		
4-6	PID SF	SF. (SF)	0.40		
4-7	PID lower limit	o_L. (o_L)	00		
4-8	PID higher limit	o_H. (o_H)	1000		
PID No. 6					
4-0	Initial screen	Pid. (P _{id})	SEt		
4-1	PID P	P. (P)	30		
4-2	PID hysteresis	dF. (dF)	20unit		
4-3	PID I	I. (I)	120		
4-4	PID D	d. (d)	30		
4-5	PID MR	mr. (mr)	00		
4-6	PID SF	SF. (SF)	0.40		
4-7	PID lower limit	o_L. (o_L)	00		
4-8	PID higher limit	o_H. (o_H)	1000		
Zone PID					
4-10	Initial screen	Pid. (P _{id})	SEt		
4-11	Zone ON/OFF	ZonE. (ZonE)	oFF		
4-12	Zone 1 SP	Z1SP. (Z1SP)	0unit		
4-13	Zone 2 SP	Z2SP. (Z2SP)	0unit		
4-14	Zone 3 SP	Z3SP. (Z3SP)	0unit		
4-15	Zone hysteresis	ZHYS. (ZHYS)	20unit		

Screen No.	Parameter (Item)/Screen	Initial value	Setting/Selection	Remarks
5-0	Initial screen	init. (i_n_i_t)	5EE	
5-1	Pattern No. designation	Ptn. (P_t_n)	4	
5-2	Time designation	tmUn. (t_m_u_n)	HN	
5-3	With/without power failure compensation	SAVE. (S·V_E)	oFF	
5-4	Input abnormality code	So. (S_o)	HLd	
5-5	Measuring range	rAnG. (r_A_n_G)	05	
5-6	Input unit	Unit. (U_n_i_t)	c	
5-7	Input scale lower limit value	Sc_L. (S_c_L)	00	
5-8	Input scale higher limit value	Sc_H. (S_c_H)	1000	
5-9	Input scale decimal point	ScdP. (S_c_d_P)	00	
5-10	PV bias	PV_b. (P_V_b)	0unit	
5-11	PV filter	PV_F. (P_V_F)	0	
5-12	Control characteristics	Act. (A_c_t)	rA	
5-13	Proportional cycle	o_C. (o_C)	Y:30 P:3	
5-14	Lower limit value of SV setting	SV_L. (S_V_L)	00	
5-15	Higher limit value of SV setting	SV_H. (S_V_H)	8000	
5-16	External control input 2 code	di2c. (d_i_2_c)	non	
5-17	External control input 3 code	di3c. (d_i_3_c)	non	
5-18	External control input 4 code	di4c. (d_i_4_c)	non	
5-19	EV1 action type	E1_m. (E_1_m)	Hd	
5-20	EV1 hysteresis	E1_d. (E_1_d)	5unit	
5-21	EV1 standby setting	E1_i. (E_1_i)	1	
5-22	EV2 action type	E2_m. (E_2_m)	Ld	
5-23	EV2 hysteresis	E2_d. (E_2_d)	5unit	
5-24	EV2 standby setting	E2_i. (E_2_i)	1	
5-25	EV3 action type	E3_m. (E_3_m)	run	
5-26	EV3 hysteresis	E3_d. (E_3_d)	5unit	
5-27	EV3 standby setting	E3_i. (E_3_i)	1	
5-28	Status output 1 code	do1c. (d_o_1_c)	non	
5-29	Status output 2 code	do2c. (d_o_2_c)	non	
5-30	Status output 3 code	do3c. (d_o_3_c)	non	
5-31	Status output 4 code	do4c. (d_o_4_c)	non	
5-32	Analog output type	Ao_m. (A_o_m)	PV	
5-33	Analog output scale lower limit	Ao_L. (A_o_L)	00	
5-34	Analog output scale higher limit	Ao_H. (A_o_H)	8000	
5-35	Communication mode	comm. (c_o_m_m)	Loc	
5-36	Communication address	Addr. (A_d_d_r)	1	
5-37	Communication speed	bPS. (b_P_S)	1200	
5-38	Communication data format	dAtA. (d_A_t_A)	7E1	
5-39	Start character	SchA. (S_c_h_A)	5E4	
5-40	BCC operation	bcc. (b_c_c)	1	
5-41	Delay time	dELy. (d_E_L_Y)	20	
5-42	Communication memory mode	mEm. (m_E_m)	EEP	
5-43	Keylock	Lock. (L_o_c_k)	oFF	

100%

Pattern No.											
Start SV	90										
The number of steps											
TS1 ON step	80										
TS1 ON time											
TS1 OFF step	70										
TS1 OFF time											
TS2 ON step											
TS2 ON time	50										
TS2 OFF step											
TS2 OFF time	40										
EV1 setting	30										
EV2 setting											
EV3 setting	20										
The number of pattern executions											
Guarantee soak	10										
PV start	0										
Step No.		1	2	3	4	5	6	7	8	9	10
SV (set value)											
Time											
PID No. (0~6)											

PID No.	1	2	3	4	5	6
P						
I						
D						
Hysteresis						
MR						
Target value function						
Higher limit of output limiter						
Lower limit of output limiter						

Zone PID	
Zone PID ON/OFF	
Zone 1 SP	
Zone 2 SP	
Zone 3 SP	
Zone hysteresis	





★ Copy these pages for your use as occasion demands.

9. Specifications

■ Display

● Display means	Digital display	: PV	Red 7 segments LED 4 digits
		: SV	Green 7 segments LED 4 digits
		: PTN	Green 7 segments LED 1 digit
		: STEP	Green 7 segments LED 2 digits
	Status display	: OUT	Green LED lamp indication
		: EV1~3 (3 points)	Orange LED lamp indication
		: AT	Green LED lamp indication
		: MAN	Green LED lamp indication
		: COM	Green LED lamp indication
		: DO1~4 (4 points)	Green LED lamp indication
		: GUA	Green LED lamp indication
		: RUN	Green LED lamp indication (blinks during FIX)
		: HLD	Green LED lamp indication
		: ↗ "ascend"	Green LED lamp indication
		: → "level"	Green LED lamp indication
		: ↘ "descend"	Green LED lamp indication
● Display accuracy		: $\pm(0.3\%FS + 1 \text{ digit})$, with restriction depending on measuring range, CJ error excluded.	
● Display accuracy maintaining range		: $23^{\circ}\text{C} \pm 5^{\circ}\text{C}$	
● Display resolution		: Differs by measuring range (0.001, 0.01, 0.1 and 1)	
● Measured value display range		: -10%~110% of measuring range (-210~680°C for Pt -200~600°C range)	
● Display updating cycle		: 0.25 second	
● Input scaling		: Possible during linear input (current and voltage) (-1999~9999, span 10~5000, decimal point position variable)	

■ Setting

● Local Setting		: Operated by 8 keys ( ,  ,  , ENT, GRP, PTN, STEP, ) on the front panel	
● SV setting range		: Same as measuring range (within setting limiter)	
● Setting limiter		: Individual setting for higher and lower limits, any value is selectable within measuring range (Lower limit < Higher limit)	
● Keylock		: OFF, 1~3 (4 levels)	
● Setting of unit		: °C or °F selectable for sensor input	

■ Input

● Type of input		: Selectable from multiple (TC, Pt, mV, V) and current (mA)	
● Thermocouple		: Input impedance 500 kΩ minimum	
		: External resistance tolerance 100 Ω maximum	
		: Influence of lead wire tolerance 1.2μV/10 Ω	
		: Burnout function standard up scale	
		: Cold junction compensation accuracy	Within the accuracy maintaining range $\pm 1^{\circ}\text{C}$ Ambient temperature 5~45°C $\pm 2^{\circ}\text{C}$
		*1 : For K, T and U thermocouples with indication values below -100°C, $\pm 0.7\%$ FS	
		*2 : Accuracy guarantee not applicable to B thermocouple below 400°C (752°F).	

● R.T.D.		: Normal current: 0.25 mA	
		: Lead wire tolerance 5 Ω maximum/wire (3 lead wires should have the same resistance.)	
		: Influence of lead wire tolerance (error in temperature)	
		0.3°C maximum in the case of 5 Ω/wire	
		0.7°C maximum in the case of 10 Ω/wire	
		1.6°C maximum in the case of 20 Ω/wire	

● Voltage		: Input impedance 500 kΩ minimum	
● Current		: mA to be taken care of by external resistor 250 Ω	
● Sampling cycle		: 0.25 second	
● PV filter		: 0~100 seconds	
● PV bias		: -1999~2000 units	
● Isolation		: Not insulated from system and DI but insulated from others	

■ Control

● Control mode		: Expert PID control with auto tuning function RA (heating)/DA (cooling) action	
● Type of control output/rating		: Contact 1c 240V AC 2.5A(resistive load) 1.0A (inductive load) SSR drive voltage 12V \pm 1.5V DC (Maximum load current 30mA) Current 4~20mA (Maximum load resistance 600 Ω) Voltage 0~10V (Maximum load current 2mA)	
● Resolution		: About 1/8000	
● Accuracy of output		: $\pm 1.0\%$ FS (5~100%)	

- Control output
 - Proportional band (P) : OFF or 0.1~999.9% FS (ON-OFF action by OFF)
 - Integral time (I) : OFF or 1~6000 seconds (P or PD action by OFF)
 - Derivative time (D) : OFF or 1~3600 seconds (P or PI action by OFF)
 - Target value function : OFF or 0.01~1.00
 - ON/OFF hysteresis : 1~999 units
 - Manual reset : $\pm 50.0\%$ (Effective when I = OFF)
 - Output limiter : Lower limit 0.0~99.9%, higher limit 0.1~100.0%
 - Proportional cycle : 1~120 seconds (when contact and SSR drive voltage output)
 - Manual control : 0.0~100.0% Setting resolution 0.1
- Control output characteristic : RA/DA to be set by front key
- Isolation : Contact output insulated from all
AO (analog output) not insulated from SSR drive voltage, current or voltage output but insulated from others

- External control input (DI)
 - Number of input points : 4
 - Type of input : Edge or level input (none, RUN/RST, HLD, ADV, FIX and start pattern No.)
DI1 fixed to RUN/RST for DI2~4, selectable from none, RUN/RST, HLD, ADV, FIX and start pattern No.)
 - Input rating : Voltage 5V DC (0.5mA/1 input)
 - Input holding time : Minimum 0.125 seconds
 - Isolation : Not insulated from input and system but insulated from others.
 - Action input : No-voltage contact or open collector

- Event output
 - Contact output rating : Normal open (1a \times 3 common) 240V AC 1A (resistive load)
 - Action : ON-OFF action
 - Hysteresis : 1~999 units (during alarm output)
 - Types : Selectable from the following 16 types respectively for EV1, EV2 and EV3
No selection, Higher limit deviation, Lower limit deviation, Outside higher/lower limit deviations, Within higher/lower limit deviations, Higher limit absolute value, Lower limit absolute value, Scaleover, Hold, Guarantee soak, Time signal (2 types), RUN status, step signal, End signal, FIX
- Event setting range:
 - Absolute value alarm : Within measuring range
 - Deviation alarm : Higher limit deviation -1999~2000 units, lower limit deviation -1999~2000 units
 - Outside higher/lower limit deviations : 0~2000 units
 - Within higher/lower limit deviations : 0~2000 units
- Standby action : Selectable from the following 4 types respectively for EV1, EV2 and EV3
None, Standby 1 (standby only when power is applied), Standby 2 (standby when power is applied, when SV in execution is changed, or when switching RST to RUN) and Standby 3 (input abnormality not output [Control mode])
- Output updating cycle : 0.25 second
- Isolation : Insulated from other inputs

- Communication function (option)
 - Type of communication : RS-232C or RS-485
 - Communication system : RS-232C/3-line type half duplex system, RS-485/2-line type half duplex multi-drop (bus) system
 - Synchronization system : Start-stop synchronization system
 - Communication distance : RS-232C/Max. 15m, RS-485/Max. 500m (depending on conditions)
 - Communication address : 1~255
 - Communication speed : 1200, 2400, 4800, 9600, 19200 bps
 - Data format : 7 bits, even parity, 1 stop bit or 8 bits, non-parity, 1 stop bit
 - Communication delay : 1~100 (0.512msec/unit)
 - Communication BCC : Selectable from Addition (ADD), Addition + two' s complement (ADD_two' s cmp), Exclusive OR (XOR) and (None)
 - Communication memory mode : Selectable from EEP, rAm and r_E
 - Communication code : ASCII code
 - Communication protocol : Shimaden's standard protocol
 - Number of connectable instruments : 1 for RS-232C, 31 for RS-485 (Address setting 1~255)
 - Isolation : insulated from other inputs and outputs
 - Others : Start character and BCC operation method also selectable

- Analog output (option)
 - Number of output points : 1
 - Type of analog output : Selectable from measured value, target value (SV in execution) and control output
 - Output specification/rating : Current 4~20mA DC (Maximum load resistance 300 Ω)
Voltage 0~10V DC (Maximum load resistance 2mA)
0~10mV DC (Output resistance 10 Ω)
 - Output accuracy : $\pm 0.3\%$ FS (Comprehensive accuracy when measured value is output $\pm 0.6\%$ FS)

● Scaling	: Within measuring range or output range (inversed scaling possible)
● Output resolution	: About 1/10000
● Output updating cycle	: 0.25 second
● Isolation	: Not insulated from P.I.V. control output but insulated from others
■ Status output (DO) (option)	
● Number of output points	: 4
● Type of output	: None, scaleover, hold, guarantee soak, time signal (2 types), RUN status, step signal, end signal, FIX
● Output specification/rating	: Open collector darlington output, voltage 24V DC (maximum load current 20mA), saturation voltage during status output ON 1.2V
● Output updating cycle	: 0.25 second
● Isolation	: Insulated from other inputs and outputs
■ Program	
● Number of patterns	: Maximum 4 (setting 1, 2 or 4 possible)
● Number of steps	: Maximum 10~40 (Total number of steps = 40)
● Number of PID types	: Maximum 6
● Number of zone PID types	: Maximum 3
● Zone hysteresis	: 0~999 units
● Time setting	: 0 hour 0 minute~99 hours 59 minutes or 0 minute 0 second~99 minutes 59 seconds/1 step
● Setting resolution	: 1 minute or 1 second
● Accuracy of time	: ± (set time × 0.02% + 0.25 second)
● Setting for each step	: SV, step time and PID No.
● Time signal	: 2 outputs/pattern, to be set within time setting range
● Number of pattern executions	: Maximum 9999
● PV start	: ON/OFF
● Guarantee soak	: OFF, 1~999 units
● Hold	: Front key input or external control input
● Advance	: Front key input or external control input
● Power failure compensation	: ON/OFF (guarantee not applicable to the period of time of step in which power failure occurs)
■ General specification	
● Data storage	: Non-volatile memory (EEPROM)
● Environmental conditions for instrument operation:	
Temperature	: -10~50°C
Humidity	: 90% RH or less (no dew condensation)
Height	: 2000m from the sea level or lower
Category	: II
Degree of pollution	: 2
● Storage temperature	: -20~65°C
● Supply voltage	: 100~240V AC±10% 50/60Hz 24V AC/DC±10% (option)
● Input/noise removal ratio	: 50 dB or higher in normal mode (50/60 Hz) 130 dB or higher in common mode (50/60 Hz)
● Insulation resistance	: Between input/output terminals and power terminal 500V DC 20 MΩ or above Between input/output terminals and protective conductor terminal 500V DC 20 MΩ or above
● Dielectric strength	: Between input/output terminals and power terminal 2300V AC/minute Between power terminal and protective conductor terminal 1500V AC/minute
● Power consumption	: 16VA maximum for AC, 7W for DC
● Conformity with standards	
Safety	: IEC61010-1 and EN61010-1
EMC	: EN61326 : 1997+A1 : 1998 , A2 : 2001 , A3 : 2003
● Protective structure	: Only front panel has dust-proof and drip-proof structure equivalent to IP66.
● Material of case	: PPO (equivalent to UL94V-1)
● External dimensions	: H96 × W96 × D111mm (Panel depth: 100)
● Panel thickness	: 1~4mm
● Mounting dimensions	: H92 × W92mm
● Weight	: Approximately 450g

产品中有毒有害物质或元素的名称及含量

部件名称	有毒有害物质或元素					
	铅 (Pb)	汞 (Hg)	镉 (Cd)	六价铬 (Cr (VI))	多溴联苯 (PBB)	多溴二苯醚 (PBDE)
印制电路板	×	○	○	○	○	○
电子元器件	×	○	○	○	○	○
接线端子	○	○	○	○	○	○
外壳	○	○	○	○	○	○

○:表示该有毒有害物质在该部件所有均质材料中的含量均在SJ/T 11363-2006 标准规定的限量要求以下。
 ×:表示该有毒有害物质至少在该部件的某一均质材料中的含量超出 SJ/T 11363-2006 标准规定的限量要求。

Distributed in New Zealand by:

Intech INSTRUMENTS LTD

Christchurch Auckland www.intech.co.nz
 Ph: +6433430646 098271930 sales@intech.co.nz
 Fx: +6433430649 098271931

The contents of this manual are subject to change without notice.

Temperature and Humidity Control Specialists
SHIMADEN CO., LTD.

Head Office: 2-30-10 Kitamachi, Nerima-Ku, Tokyo 179-0081 Japan
 Phone: +81-3-3931-7891 Fax: +81-3-3931-3089
 E-MAIL: exp-dept@shimaden.co.jp URL: <http://www.shimaden.co.jp>

PRINTED IN JAPAN