

FP23 Series Programmable Controller

Instruction Manual

Communication Interface (RS-232C/RS-485)

Thank you for purchasing the Shimaden FP23 Series Digital Controller.

Check that the delivered product is the correct item you ordered. Do not begin operating this product until you have read and thoroughly understood the contents of this Instruction Manual.

SHIMADEN CO., LTD.

MFP23-E04-A
August 2005

Request

Make sure that this instruction manual is given to the final user of the device.
Keep this manual at the work site during operation of the FP23 Series.

Preface

This Instruction Manual describes the basic functions and method of use of the “Communications Interface (RS-232C/RS-485)” for the FP23 Series Programmable Controller.

For an outline description of this controller and details of its incorporated functions, and details on wiring, installation, operation and routine maintenance of the FP23 Series, refer to the separate document “FP23 Series Programmable Controller, Instruction Manual” (simply called the “Instruction Manual” from here on.)

Safety Precautions



Warning

The FP23 Series Programmable Controller is designed for controlling temperature, humidity and other physical quantities in general industrial facilities.

It must not be used in any way that may adversely affect the safety, health or working conditions of those who come into contact with the effects of its use.

When used, adequate and effective safety countermeasures must be provided at all times by the user. No warranty, express or implied, is valid when this device is used without the proper safety countermeasures.



Warning

- Before you start to use this device, install it in a control panel or the like and avoid touching the terminals.
 - Do not open this device’s case, and touch the boards or inside of the case with your hands or a conductor.
The user should never repair or modify this device.
Doing so might cause an accident that may result in death or serious bodily injury from electric shock.
-
-



Caution

To avoid damage to connected peripheral devices, facilities or the product itself due to malfunction of this device, safety countermeasures such as proper installation of the fuse or installation of overheating protection must be taken before use. No warranty, express or implied, is valid in the case of use resulting in an accident without having taken the proper safety countermeasures.

Contents

Contents	iii
1 OUTLINE.....	1
1-1 Communication Interface	1
1-2 Communication Protocol and Specifications.....	1
2 CONNECTING THE CONTROLLER TO A HOST COMPUTER	3
2-1 When the RS-232C Interface Is Used.....	3
2-2 When the RS-485 Interface Is Used	3
3 COMMUNICATION SETUP PARAMETERS	5
3-1 Setting the Communication Mode (No.1-1).....	5
3-2 Setting the Communication Protocol (No.5-8).....	6
3-3 Setting the Device Address (No.5-8)	6
3-4 Setting the Communication Speed (No.5-8)	7
3-5 Setting the Communication Memory Mode (No.5-8).....	7
3-6 Setting the Communication Data Length (No.5-9)	7
3-7 Setting the Communication Parity (No.5-9).....	8
3-8 Setting the Communication Stop Bit (No.5-9)	8
3-9 Setting the Communication Delay Time (No.5-9).....	8
3-10 Setting the Communication Control Code (No.5-10).....	8
3-11 Setting the Communication BCC Data Operation Method (No.5-10).....	9
4 EXPLANATION OF SHIMADEN PROTOCOL.....	11
4-1 Communication Procedure	11
(1) Master and slave.....	11
(2) Communication procedure.....	11
(3) Timeout.....	11
4-2 Communication Format	11
(1) Outline of communication format	12
(2) Details of basic format section I	13
(3) Details of basic format section II	13
(4) Outline of text section	15

4-3	Details of Read Command (R).....	17
(1)	Format of Read command (R).....	17
(2)	Format of normal response to Read command (R).....	18
(3)	Format of error response to Read command (R).....	19
4-4	Details of Write Command (W).....	20
(1)	Format of Write command (W).....	20
(2)	Format of normal response to Write command (W).....	22
(3)	Format of error response to Write command (W).....	22
4-5	Details of Broadcast Command (B).....	23
(1)	Format of broadcast command.....	23
4-6	Details of Response Codes.....	24
(1)	Type of response codes.....	24
(2)	Order of priority of response codes.....	24
5	EXPLANATION OF MODBUS COMMUNICATION PROTOCOL.....	25
5-1	Outline of Transfer Mode.....	25
(1)	ASCII mode.....	25
(2)	RTU mode.....	25
5-2	Configuration of Messages.....	25
(1)	ASCII mode.....	25
(2)	RTU mode.....	26
5-3	Slave Address.....	26
5-4	Function Codes.....	26
5-5	Data.....	27
5-6	Error Check.....	27
(1)	ASCII mode.....	27
(2)	RTU mode.....	27
5-7	Examples of Messages.....	28
(1)	ASCII mode.....	28
(2)	RTU mode.....	30
6	LIST OF COMMUNICATION DATA ADDRESSES.....	33
6-1	Outline of Communication Data Address.....	33
(1)	Data address and reading/writing the data address.....	33
(2)	Reading/writing parameters in a 2-loop specification.....	33
(3)	Reading/writing “reserved” in the parameter section.....	33
(4)	Reading/writing option-related parameters.....	33
(5)	Parameters not displayed on the front panel.....	33
(6)	Handling data.....	34
(7)	Execution of broadcast.....	34
(8)	Annotation of time data.....	34

6-2	Communication Data Address	35
7	APPENDIX	59
7-1	Setting Range Code Table.....	59
7-2	ASCII Code Table	61

This page left intentionally blank

1 OUTLINE

1-1 Communication Interface

As an option, the FP23 Series supports two communication interfaces: RS-232C and RS-485. Using these communication interfaces, you can set up or read various data from a personal computer.

The RS-232C and RS-485 communication interface are data communication standards determined by the EIA (Electronic Industries Alliance) of the United States. These standards stipulate electrical and mechanical so-called "hardware" information, and do not define the software aspects of data transfer procedures. For this reason, communication is not possible unconditionally even between devices that support the same interface.

For this reason, the user must be fully familiar with and understand data transfer specifications and transfer procedures.

The RS-485 interface allows multiple FP23s to be connected in parallel. Though there are currently few personal computers that support the RS-485 interface, the RS-485 interface can be used by connecting a third-party RS-232C/RS-485 converter.

1-2 Communication Protocol and Specifications

The FP23 Series supports the SHIMADEN standard protocol and MODBUS communication protocol.

Common to each protocol

Signal level	EIA RS-232, RS-485 compliant
Communication system	RS-232C 3-line half-duplex system RS-485 2-line half-duplex multidrop (bus) system
Synchronization system	Start-stop synchronization
Communication distance	RS-232C max. 15m RS-485 max. 500 m (depending on connection conditions)
Communication speed	2400/4800/9600/19200 bps
Transmission procedure	Non-procedural
Communication delay time	1 to 50 ms
Communication code	ASCII code
Number of connectable device	RS-232C 1 RS-485 max. 31 (depending on connection conditions)

SHIMADEN standard protocol

This is a SHIMADEN proprietary communication protocol.
The table below shows the specifications of this protocol.

Data length	7/8 bits
Parity	EVEN, ODD , NONE
Stop bit	1/2 bits
Communication address	01 to 98
Communication memory mode	EEP/RAM/R_E
Communication BBC	Add/Add two's cmp/XOR/NONE

MODBUS communication protocol

This is a communication protocol developed for PLCs by Modicon Inc.
Though the specifications of this protocol are open, only the communication protocol is defined in this protocol, and physical layers such as communication medium are not stipulated.

The table below shows the specifications of this protocol.

- ASCII mode

Data length	Fixed to 7 bits
Parity	EVEN, ODD , NONE
Stop bit	1 bit, 2 bits
Control code	_CRLF
Error check	LRC

- RTU mode

Data length	Fixed to 8 bits
Parity	EVEN, ODD , NONE
Stop bit	1 bit, 2 bits
Control code	None
Error check	CRC
Function code	03H) Read data 06H) Write data

2 CONNECTING THE CONTROLLER TO A HOST COMPUTER

The FP23 Series controller is connected to the host computer by three lines, send data, receive data and signal ground.

The following shows connection examples.

For details, refer to the User's Manual for the host computer.

2-1 When the RS-232C Interface Is Used

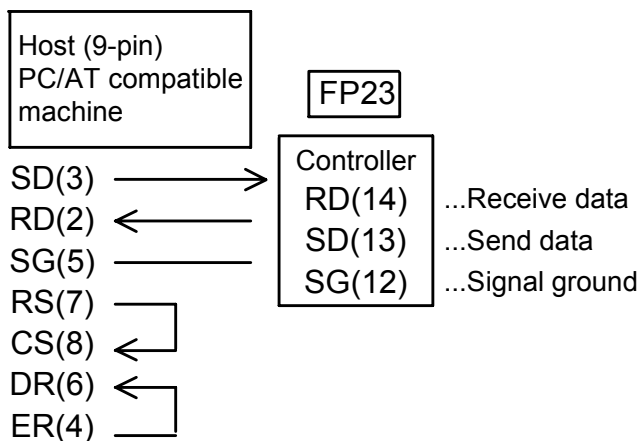

Numbers in parentheses () are connector pin Nos.

2-2 When the RS-485 Interface Is Used

The I/O logic level of the F23 basically is as follows:

Mark state: - terminal < + terminal Space state: - terminal > + terminal

Note, however, that the + terminal, and – terminal of the controller are high-impedance before transmission is started, and the above levels are output during transmission.

If necessary, attach a terminator of about $1/2W$ 120Ω to the endmost terminal (between + and – terminals). Operation when a terminator attached to two or more units is not guaranteed.

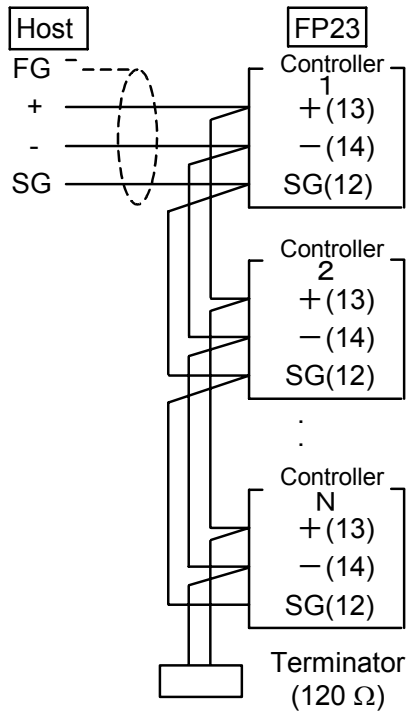

About tri-state output control

When the RS-485 interface is used, the connection becomes a multidrop connection. For this reason, to avoid conflict between send signals, the transmission output is held at high-impedance at all times during reception or when communication is not performed.

In tri-state control, a delay of about 1 msec (max.) after end of transmission of the end bit of the end character up to the return from high impedance is generated.

To absorb this delay time, be sure to set a delay time of several seconds or more when performing transmission immediately after the host computer ends reception.

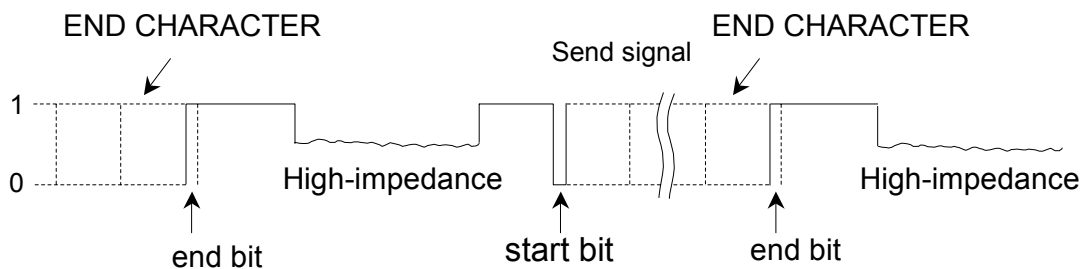

3 COMMUNICATION SETUP PARAMETERS

The FP23 Series has 11 communication setup parameters, of which two are exclusively for the SHIMADEN standard protocol.

- Setting the communication mode (No.1-1)
- Setting the communication protocol (No.5-8)
- Setting the device address (No.5-8)
- Setting the communication speed (No.5-8)
- Setting the communication memory mode (No.5-8)
- Setting the communication data length (No.5-9)
- Setting the communication parity (No.5-9)
- Setting the communication stop bit (No.5-9)
- Setting the communication delay time (No.5-9)
- Setting the communication control code (No.5-10): SHIMADEN standard protocol only
- Setting the BCC data operation method (No.5-10): SHIMADEN standard protocol only

These parameters can be set or changed only by using the keys on the front panel and not by communication.

When setting these parameters, refer to the “LCD Flow Chart” in the Instruction Manual and follow the instructions in this section.

3-1 Setting the Communication Mode (No.1-1)

1-1			Setting range	: LOC, COM
AT :	OFF	C _H	Default	: LOC
MAN :	OFF	1		
COM 	COM			

Set the communication mode.

Note, however, that COM can be only changed to LOC using the front panel keys.

LOC	Only read command enabled by communication (COM LED on front panel out)
COM	Read and write commands enabled by communication (COM LED on front panel lit)

Note

When the communication mode is set to COM, changing of all communication setup parameters is prevented by the key lock.

To prevent uncontrollable situations such as host program runaway, communication between the FP23 and the host can be forcibly terminated by holding down the ENT and STEP keys simultaneously for at least three seconds.

3-2 Setting the Communication Protocol (No.5-8)

5-8

COM PROT	SHIMADEN
ADDR	1
BPS	: 9600
MEM	: EEP

Setting range : SHIMADEN, MOD_ASC, MOD_RTU

Default : SHIMADEN

Set the communication protocol.

SHIMADEN	SHIMADEN standard protocol
MOD_ASC	MODBUS communication protocol (ASCII mode)
MOD_RTU	MODBUS communication protocol (RTU mode)

There are two MODBUS communication protocol modes, ASCII mode and RTU mode. Either of these modes can be selected. Note, however, that all devices on the same network must be set to the same MODBUS communication protocol mode.

In the ASCII mode, 1-byte (8-bit) data is converted to two ASCII code characters before it is transferred.

In the RTU mode, 1-byte (8-bit) data is transferred as it is.

For this reason, it can be said that the transfer efficiency of the RTU mode is better than that of the ASCII mode.

3-3 Setting the Device Address (No.5-8)

5-8

COM PROT	: SHIMADEN
ADDR	1
BPS	: 9600
MEM	: EEP

Setting range : 1 to 98

Default : 1

In the case of the RS-232C interface, the connection between the FP23 and the host computer is a 1:1 connection. However, in the case of the RS-485 interface, the connection becomes a multidrop connection, which means that a maximum of 31 FP23 units can be connected.

However, actual communication must be performed by a 1:1 connection. For this reason, unique addresses (machine Nos.) are provided for each of the devices.

Addresses are set within the range 01 to 98, and addresses can be set to a maximum of 31 machines.

The preset address is used as the address for infrared communication with the front panel of the device.

For details, refer to the Instruction Manual for the Parameter Setup Tool (sold separately).

3-4 Setting the Communication Speed (No.5-8)

5-8

COM PROT:	SHIMADEN
ADDR:	1
BPS <input checked="" type="checkbox"/>	9600
MEM :	EEP

Setting range : 2400/4800/9600/19200 bps

Default : 9600 bps

Select from 2400, 4800, 9600, 19200 bps as the communication speed, and set.

3-5 Setting the Communication Memory Mode (No.5-8)

5-8

COM PROT:	SHIMADEN
ADDR:	1
BPS :	9600
MEM <input checked="" type="checkbox"/>	EEP

Setting range : EEP/RAM/R_E

Default : EEP

This device uses non-volatile memory (EEPROM) for storing parameter setups. As the write cycle or number of times that the EEPROM can be written is already determined, periodically rewriting SV data, for example, in EEPROM by communication will shorten the EEPROM's life.

To prevent this when data is frequently rewritten by communication, the EEPROM can also be set so that it is not rewritten and only RAM data is overwritten. This will prolong the life of the EEPROM.

- EEP** In this mode, the EEPROM is rewritten each time that data is changed by communication. For this reason, data is held on the device even if the device is turned OFF.
- RAM** In this mode, only RAM data is rewritten and data in EEPROM is not rewritten even if data is changed by communication. For this reason, data in RAM is cleared when the device is turned OFF, and the device starts up with the data in EEPROM when it is turned ON again.
- R_E** In this mode, SV1 to SV10, OUT, and COM mode data is written only to RAM. Other data is written to EEPROM.

3-6 Setting the Communication Data Length (No.5-9)

5-9

COM DATA <input checked="" type="checkbox"/>	7
PARI :	EVEN
STOP:	1
DELY:	10 ms

7 or 8 bits can be set only in the SHIMADEN standard protocol. The default data length is 7 bits.

The data length in the MODBUS communication protocol is fixed to 7 bits in the ASCII mode and 8 bits in the RTU mode.

3-7 Setting the Communication Parity (No.5-9)

5-9

COM DATA:	7
PARI <input checked="" type="checkbox"/>	EVEN
STOP:	1
DELY:	10 ms

Setting range : EVEN, ODD, NONE

Default : EVEN

Set the parity check method for detecting errors in data in data communication.

3-8 Setting the Communication Stop Bit (No.5-9)

5-9

COM DATA:	7
PARI :	EVEN
STOP <input checked="" type="checkbox"/>	1
DELY:	10 ms

Setting range : 1, 2

Default : 1

3-9 Setting the Communication Delay Time (No.5-9)

5-9

COM DATA:	7
PARI :	EVEN
STOP:	1
DELY <input checked="" type="checkbox"/>	10 ms

Setting range : 1 to 50 ms

Default : 10 ms

Set the minimum delay time from reception of the communication command up to transmission.

Note

- In the case of the RS-485 interface, it sometimes takes time to perform tri-state control due to the line converter, which may cause signals to collide. This can be avoided at this time by lengthening the delay time. Particular care must be taken when communication is set to a low speed (2400 bps).
- The actual delay time from reception of the communication command up to transmission is the total time required to process commands by the software added to the above delay time. In particular, it sometimes takes about 400 ms to process commands in the case of the write command.

3-10 Setting the Communication Control Code (No.5-10)

This setting item is available only in the SHIMADEN standard protocol. Set the communication control code.

5-10

COM CTRL <input checked="" type="checkbox"/>	STX_ETX_CR
BCC :	ADD

Setting range : STX_ETX_CR, STX_ETX_CRLF,
@_:_CR

Default : STX_ETX_CR

3-11 Setting the Communication BCC Data Operation Method (No.5-10)

This setting item is available only in the SHIMADEN standard protocol.

5-10

COM	CTRL	:	STX_ETX_CR
BCC			<input checked="" type="checkbox"/> ADD

Setting range : ADD, ADD_two's cmp, XOR, None

Default : ADD

There are four operation methods for the BCC (Block Check Character) data:

ADD Addition operation

ADD_two's cmp The two's complement of the lower 1 byte of the addition operation result is taken.

XOR XOR (exclusive OR) operation is performed.

None BCC operation is not performed.

For details, see "4-2 (3) Details of basic format section II."

This page left intentionally blank

4 EXPLANATION OF SHIMADEN PROTOCOL

4-1 Communication Procedure

(1) Master and slave

The host (personal computer or PLC) is the master.

The FP23 is the slave.

Communication starts by the communication command from the master, and ends by the communication response from the slave.

Note, however, that a communication response is not performed when an error (e.g. communication format error or BCC error) occurs, or when a broadcast command is issued.

(2) Communication procedure

Communication is performed by a response being returned by the slave to the master. During communication, the transmission right shifts between the master and the slave.

(3) Timeout

The FP23 regards instances where reception of the end character does not end within one second of receiving the start character as a timeout, disables that command, and stands by for the next command (new start character).

4-2 Communication Format

The FP23 Series supports various protocols, and so various selections can be made by the communication format (control codes, BCC operation method) or communication data format (data bit length, parity, stop bit length).

However, for ease of use and to avoid confusion when setting up communications, we recommend using the following format:

	Recommended Format	
Control code	STX_ETX_CR	
BCC operation method	ADD	
Data bit length	7	8
Parity	EVEN	NONE
Stop bit length	1	1

(1) Outline of communication format

The formats of the communications commands sent from the master and the communication response formats sent from the slave comprise three blocks: basic format section I, text section and basic format section II.

Basic format sections I and II are common to the Read command (R), Write command (W) and during communication responses. Note, however, that the operation result data at that time is inserted as the BCC data of i ((13) and (14)). The text section differs according to factors such as the command type, data address and communication response.

Communication command format

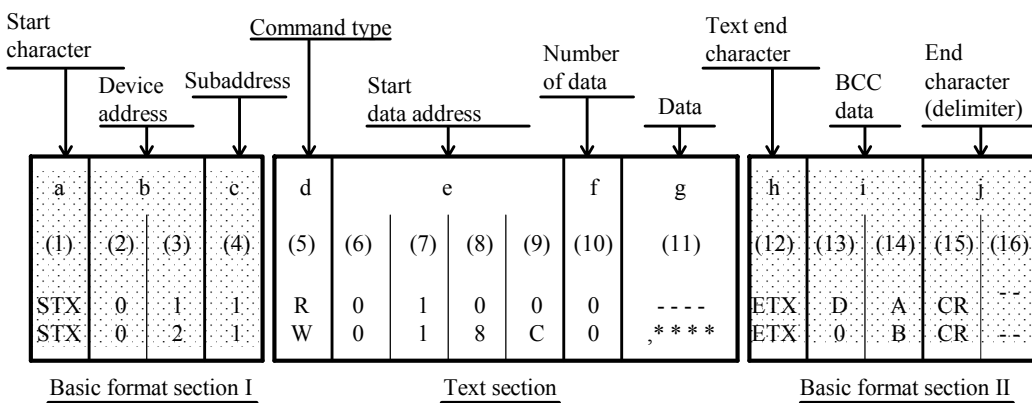

Communication response format

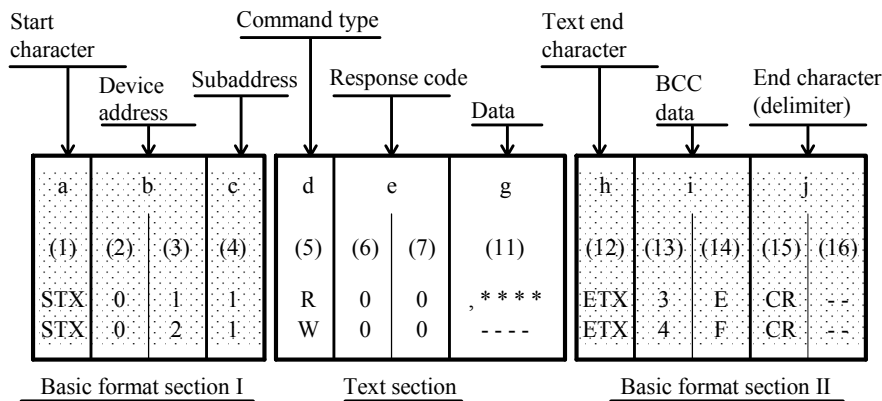

(2) Details of basic format section I**a: Start character [(1): 1 digit/STX (02H) or "@" (40H)]**

- The start character indicates the start of the communication message.
- When the start character is received, it is judged to be the 1st character of a new communication message.
- Select the start character and text end character as a pair.

STX (02H) --- Select by ETX (03H)

"@" (40H) ---- Select by ":" (3AH)

b: Device address [(2), (3): 2 digits]

- Specify the device to communicate with.
- Specify the address within the range 1 to 98 (decimal).
- Binary 8-bit data (1: 0000 0001 to 98: 0110 0010) is divided into upper 4 bits and lower 4 bits, and converted to ASCII data.
 - (2): Data obtained by converting the upper 4 bits to ASCII
 - (3): Data obtained by converting the lower 4 bits to ASCII
- Device address=0 (30H, 30H) cannot be used as the device address as it is used when the broadcast instruction is issued.

c: Subaddress [(4): 1 digit]

- In a 1-loop specification, the subaddress is fixed to 1 (31H).
In a 2-loop specification, channel 1 can be accessed by 1 (31H) and channel 2 can be accessed by 2 (32H).

(3) Details of basic format section II**h: Text end character [(12): 1 digit/ETX (03H) or ":" (3AH)]**

- Indicates the end of the text.

i: BCC data [(13), (14): 2 digits]

- The BCC (Block Check Character) data is for checking if there is an error in the communication data.
- When BCC operation results in a BCC error, a no-response state is entered.
- There are four types of BCC operation as shown below. These can be set on the front panel screen.

(1) ADD

Addition operation is performed from start character (1) through to text end character (12) in ASCII data single characters (1-byte).

(2) ADD_two's cmp

Addition operation is performed from start character (1) through to text end character (12) in ASCII data 1-character (1-byte) units, and the two's complement of the lower 1 byte of the operation result is taken.

(3) XOR

Exclusive OR is performed from after (device address ((2)) the start character through to text end character (12) in ASCII data 1-character (1-byte) units.

(4) None

BCC operation is not performed. ((13), (14) is omitted.)

- BCC data is operated in 1-byte (8-bit) units regardless of the data bit length (7 or 8).
- The lower 1-byte data of the result of the above operation is divided into upper 4 bits and lower 4 bits, and converted to ASCII data.

(13): Data obtained by converting the upper 4 bits to ASCII

(14): Data obtained by converting the lower 4 bits to ASCII

Example 1: iRead command (R) at BCC i Add setting

(1)	(2)	(3)	(4)	(5)	(6)	(7)	(8)	(9)	(10)	(12)	(13)	(14)	(15)	(16)
STX	0	1	1	R	0	1	0	0	9	ETX	E	3	CR	LF

$02H + 30H + 31H + 31H + 52H + 30H + 31H + 30H + 30H + 39H + 03H = 1E3H$

Lower 1 byte of add result (1E3H)

(13): "E" = 45H, (14): "3" = 33H

Example 2: iRead command (R) at BCC i Add_two's cmp setting

(1)	(2)	(3)	(4)	(5)	(6)	(7)	(8)	(9)	(10)	(12)	(13)	(14)	(15)	(16)
STX	0	1	1	R	0	1	0	0	9	ETX	1	D	CR	LF

$02H + 30H + 31H + 31H + 52H + 30H + 31H + 30H + 30H + 39H + 03H = 1E3H$

Lower 1 byte of add result (1E3H)

Two's complement of lower 1 byte (E3H)

(13): "1" = 31H, (14): "D" = 44H

Example 3: iRead command (R) at BCC i XOR setting

(1)	(2)	(3)	(4)	(5)	(6)	(7)	(8)	(9)	(10)	(12)	(13)	(14)	(15)	(16)
STX	0	1	1	R	0	1	0	0	9	ETX	5	9	CR	LF

$02H \ 30H \ A31H \ A31H \ A52H \ A30H \ A31H \ 30H \ 30H \ 39H \ 03H = 59H$

Note that A=XOR

Lower 1 byte of operation result (59H)

(13): "5" = 35H, (14): "9" = 39H

j: End character (delimiter) [(15), (16): 1 digit or 2 digits/CR or CR LF]

- Indicates the end of the communication message.
- The following two types can be selected as the end character:
(15), (16): CR (0DH) (LF is not appended by CR alone.)
(15), (16): CR (0DH) and LF (0AH)

Note

A response is not performed when an error such as follows is recognized in the basic format section:

- A hardware error occurred.
- The device address and subaddress differ from the address of the specified device.
- The character specified by the previous communication format is not at the specified position.
- The BCC operation result differs from the BCC data.

Data conversion converts binary data to ASCII data in 4-bit blocks.

Hex <A> to <F> are expressed in uppercase characters and are converted to ASCII data.

(4) Outline of text section

The text section differs according to the command type and communication response. For details, see “4-3 Details of Read Command (R)” and “4-4 Details of Write Command (W).”

d: Command type [(5): 1 digit]

- No response is made when a character other than “R”, “W” and “B” is recognized.

“R” (52H/uppercase character):

Indicates a Read command or a Read command response.

This is used to read (load) various FP23 data from a master personal computer or PLC.

“W” (57H/uppercase character):

Indicates a Write command or a Write command response.

This is used to write (change) various FP23 data from a master personal computer or PLC.

“B” (42H/uppercase character):

Indicates a broadcast command.

This is used to batch write (change) data to all devices that support the broadcast command from a master personal computer or PLC.

- The data is always prefixed by a comma (“, “2CH) to indicate that what follows the comma is the data.
- The number of data follows the number of data (f: (10)) in the communication command format.
- One item of data is expressed in binary 16-bit (1 word) units without a decimal point. The position of the decimal point is determined by each data.
- 16-bit data is divided into 4-bit blocks, and each block is converted to ASCII data.
- For details of data, see “4-3 Details of Read Command (R)” and “4-4 Details of Write Command (W).”

e: Response code [(6), (7): 2 digits]

- Specifies the response code for the Read command (R) and Write command. Binary 8-bit data (0 to 255) is divided into upper 4 bits and lower 4 bits, and each is converted to ASCII data.
(6): Data obtained by converting upper 4 bits to ASCII
(7): Data obtained by converting lower 4 bits to ASCII
- In the case of a normal response, "0" (30H) and "0" (30H) are specified. In the case of an error response, the error code No. is specified after conversion to ASCII data.
For details on response codes, see “4-6 Details of Response Codes.”

4-3 Details of Read Command (R)

The Read command (R) is used to read (load) various FP23 data from a master personal computer or PLC.

(1) Format of Read command (R)

- The following shows the format of the text section of the Read command (R). Basic format section I and basic format section II are common to all commands and command responses.

Text section

d	e				f
(5)	(6)	(7)	(8)	(9)	(10)
R	0	4	0	0	9
52H	30H	34H	30H	30H	39H

- D ((5)) indicates the Read command. It is fixed to “R” (52H).
- E ((6) to (9)) specifies the start data address of the data to read.
- F ((10)) specifies the number of data (words) to read.

- The above command is as follows:
 Read start data address =0400H (Hex)
 =0000 0100 0000 0000 (binary)
 Number of read data =9H (Hex)
 =1001 (binary)
 =9 (decimal)
 (actual number of data) =10 (9+1)

In other words, in this example, reading of 10 continuous items of data from data address 0400H is specified.

(2) Format of normal response to Read command (R)

- The following shows the format (text section) of a normal response to the Read command (R).
 Basic format section I and basic format section II are common to all commands and command responses.

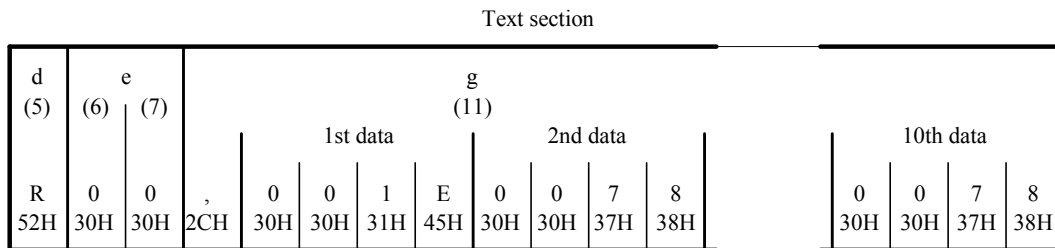

- <R(52H)> indicating a response to the Read command (R) is inserted at d ((5)).
- <00(30H and 30H)> indicating a normal response to the Read command (R) is inserted at e ((6) and (7)).
- The response data to the Read command (R) is inserted at g ((11)).

<","(2CH)> indicating the data of the data description is inserted at the beginning of the text section.

Data is inserted following the beginning of the text section in order from <data of the read start data address> for the number of <read data number>.

Nothing is inserted between data items.

One item of data is expressed in binary 16-bit (1 word) units without a decimal point, and is converted to ASCII data in 4-bit blocks before it is inserted.

The position of the decimal point is determined by each data.

The number of characters of the response data is “number of characters=1+4 x number of read data”.

- In actual terms, the following data is returned in order as the response data to the Read command (R).

	Data address 16 bits (1 word)	Data 16 bits (1 word)			
	Hex	Hex	Decimal		
Read start data address (0400H)	0	0400	001E	30	
	1	0401	0078	120	
	2	0402	001E	30	
	3	0403	0000	0	
	4	0404	0000	0	
	5	0405	0000	0	
	Number of read data (9H: 10 data)	6	0406	03E8	1000
		7	0407	0028	40
		8	0408	001E	30
		9	0409	0078	120
		040A	001E	30	
	040B	0000	0		
	040C	0000	0		

(3) Format of error response to Read command (R)

- The following shows the format (text section) of an error response to the Read command (R).
Basic format section I and basic format section II are common to all commands and command responses.

Text section

d	e	
(5)	(6)	(7)
R	0	7
52H	30H	37H

- <R(52H)> indicating a response to the Read command (R) is inserted at d ((5)).
- A response code indicating an error response to the Read command (R) is inserted at e ((6) and (7)).

Response data is not inserted in the case of an error response.

For details on error codes, see “4-6 Details of Response Codes.”

4-4 Details of Write Command (W)

The Write command (W) is used to write (change) various data on FP23 from a master personal computer or a PLC.

Caution

To use the Write command, the communication mode must be changed from LOC to COM.

The communication mode cannot be changed using the keys on the front panel.

To change the communication mode, send the following command from the master.

Command format

When ADDR=1, CTRL=STX_ETX_CR, BCC=ADD

STX	0	1	1	W	0	1	8	C	0	,	0	0	0	1	ETX	E	7	CR	
	02H	30H	31H	31H	57H	30H	31H	38H	43H	30H	2CH	30H	30H	30H	31H	03H	45H	37H	0DH

If a normal response is returned to the above command, the COM LED on the front panel lights and the communication mode switches to COM.

(1) Format of Write command (W)

- The following shows the format of the text section in the case of the Write command (W).
Basic format section I and basic format section II are common to all commands and command responses.

Text section

d	e				f	g				
(5)	(6)	(7)	(8)	(9)	(10)	(11)				
W	0	4	0	1	0	,	0	0	7	D
57H	30H	34H	30H	31H	30H	2CH	30H	30H	37H	44H

- D ((5)) indicates the Write command.
It is fixed to "W" (57H).
- E ((6) to ((9)) specifies the start data address of the write (change) data.
- F ((10)) specifies the number of write (change) data.
The number of write data is fixed to 1: "0" (30H)

- g ((11)) specifies the write (change) data.

<"(2CH)> indicating the data of the data description is inserted at the beginning of the write.

Next, the write data is inserted.

One item of data is expressed in binary 16-bit (1 word) data without a decimal point, and is converted to ASCII data in 4-bit blocks before it is inserted.

The position of the decimal point is determined by each data.

- The above command is as follows:

Write leading start address	=0401H	(Hex)
	=0000 0100 0000 0001	(binary)
Number of write data	=0H	(Hex)
	=0000	(binary)
	=0	(decimal)
(actual number of data)	=1 (0+1)	
Write data	=007DH	(Hex)
	=0000 0000 0111 1110	(binary)
	=125	(decimal)

In other words, in this example, writing (change) of one item of data (125 decimal) to data address 0401H is specified.

Data address 16 bits (1 word)		Data 16 bits (1 word)	
Hex	Decimal	Hex	Decimal
0400	1024	00C8	200
0401	1025	007D	125
0402	1026	0078	120

Write start data address (300H) → 0
Number of writer data 1 (0H)

(2) Format of normal response to Write command (W)

- The following shows the format (text section) of a normal response to the Write command (W).
Basic format section I and basic format section II are common to all commands and command responses.

Text section

d (5)	e (6) (7)	
W 57H	0 30H	0 30H

- <W(57H)> indicating a response to the Write command (W) is inserted at d ((5)).
- Response codes <00(30H and 30H)> indicating a normal response to the Write command (W) are inserted at e ((6) and (7)).

(3) Format of error response to Write command (W)

- The following shows the format (text section) of an error response to the Write command (W).
Basic format section I and basic format section II are common to all commands and command responses.

Text section

d (5)	e (6) (7)	
W 57H	0 30H	9 39H

- <W(57H)> indicating a response to the Write command (W) is inserted at d ((5)).
- A response code indicating an error response to the Read command (R) is inserted at e ((6) and (7)).

For details on error codes, see “4-6 Details of Response Codes.”

4-5 Details of Broadcast Command (B)

The Broadcast command (B) is used to batch write (change) data to all devices that support the broadcast command from a master personal computer or PLC.

The broadcast command does not have a communication response.

(1) Format of broadcast command

For details of parameters that can be broadcasted, see B on the right side of “Chapter 6 List of Communication Data Addresses.”

Ex: AT (auto tuning) execution

Device address: 00, sub-address: 1 or 2

STX	0	0	1	B	0	1	8	4	,	0	0	0	1	ETX	9	2	CR
02H	30H	30H	31H	42H	30H	31H	38H	34H	2CH	30H	30H	30H	31H	03H	39H	32H	0DH

4-6 Details of Response Codes

(1) Type of response codes

Communication responses to the Read command (R) and Write command (W) must contain a response code.

There are two types of response codes: normal response code and error response code. Response codes are expressed as binary 8-bit data (0 to 255). The table below shows the details of response codes.

Response Code List

Response Code		Code Type	Description
Binary	ASCII		
0000 0000	"0", "0":30H,30H	Normal response	Normal response code for Read command (R) or Write command (W)
0000 0001	"0", "1":30H,31H	Hardware error in text section	A hardware error such as framing overrun or parity has been detected in the data of the text section.
0000 0111	"0", "7":30H,37H	Format error in text section	The format of the text section differs from the predetermined format.
0000 1000	"0", "8":30H,38H	Data format data address, number of data error in text section	The format of the text section differs from the predetermined format, or the data address and number of data are other than specified.
0000 1001	"0", "9":30H,39H	Data error	The write data exceeds the settable range of that data.
0000 1010	"0", "A":30H,41H	Execution command error	An execution command (e.g. MAN) was received when it could not be accepted.
0000 1011	"0", "B":30H,42H	Write mode error	When data that must not be rewritten depending on the data type, a write command containing that data was received.
0000 1100	"0", "C":30H,43H	Specification, option error	A write command containing data of an unmounted specification or option was received.

(2) Order of priority of response codes

The smaller the value of the response code becomes, the higher the priority of the response code.

When multiple response codes have been issued, the response code having the higher or highest priority is returned.

5 EXPLANATION OF MODBUS COMMUNICATION PROTOCOL

The MODBUS communication protocol has two transfer modes: ASCII mode and RTU mode.

5-1 Outline of Transfer Mode

(1) ASCII mode

The 8-bit binary data in commands is divided into upper 4 bits (Hex) and lower 4 bits (Hex), each of which is sent as ASCII characters.

Data configuration

Start bit	1 bit
Data bit	7 bits/fixed
Parity bit	EVEN, ODD, NONE selectable
Stop bit	1 bit, 2 bits selectable
Error check	LRC (Longitudinal Redundancy Check)
Data communication interval	1 sec or less

(2) RTU mode

The 8-bit binary data in commands is sent as it is.

Data configuration

Start bit	1 bit
Data bit	8 bits/fixed
Parity bit	EVEN, ODD, NONE selectable
Stop bit	1 bit, 2 bits selectable
Error check	CRC-16 (Cyclic Redundancy Check)
Data communication interval	3.5 character transmission time or less

5-2 Configuration of Messages

(1) ASCII mode

In this mode, messages are configured to begin with a start character [: (colon) (3AH)], and end with an end character [CR (carriage return) (ODH)] followed by a LF (line feed) (0AH)].

Header (:)	Slave address	Function code	Data	Error check LRC	Delimiter (CR)	Delimiter (LF)
------------	---------------	---------------	------	-----------------	----------------	----------------

(2) RTU mode

In this mode, messages begin after an idle time of 3.5 characters transfer time or more, and end after an idle time of 3.5 characters transfer time or more has elapsed.

Idle 3.5 characters	Slave address	Function code	Data	Error check CRC	Idle 3.5 characters
---------------------	---------------	---------------	------	-----------------	---------------------

5-3 Slave Address

The slave address is the device No. of the slave, and is set within the range 0 to 99. The master recognizes each of the slaves by specifying the slave address in request messages.

The slave notifies the master of which slave is responding by setting and returning its own slave address to the response message.

Slave address 0 is the broadcast address and can specify all slaves. In the case of a broadcast, slaves do not return a response.

In the 1-loop specification, the slave address is the same as the device address. In the 2-loop specification, the slave address of channel 1 is the same as the device address, and the slave address of channel 2 is the device address+1.

5-4 Function Codes

A function code is a code for instructing the type of operation to the slave.

Function Code	Details
03 (03H)	Reads setting values and information from slaves.
06 (06H)	Writes to slave.

These function codes are also used for indicating whether the response message returned to the master by the slave is a normal response (positive response) or that some error has occurred (negative response).

In a positive response, the original function code is set and returned.

In a negative response, the MSB of the original function code is set to "1" and returned. For example, when "10H" has been mistakenly set as the function code, and the request message has been sent to the slave, "1" is set to the MSB and returned as "90H" as this function code is non-existent.

Also, in the case of a negative response, an error code is set to the response message and returned to notify the master of which type of error has occurred.

Error Code	Details
1 (01H)	illegal Function (non-existent function)
2 (02H)	illegal data address (non-existent data address)
3 (03H)	illegal data value (value out of setting range)

5-5 Data

The structure of data differs according to the function code.

With request messages from the master, data is configured by data item, number of data and setting data.

With response messages from a slave, data is configured by number of bytes or data in response to the request, and in the case of a negative response, an error code.

The valid data range is -32768 to 32767 (8000H to 7FFFH).

5-6 Error Check

The error check method differs according to the transfer mode.

(1) ASCII mode

As the error check for the ASCII mode, calculate the LRC up to the end of the data from the slave address, convert the resulting 8-bit data to two ASCII characters and append it to the data.

LRC calculation method

1. Create a message in the RTU mode.
2. Add up to the end of the data from the slave address, and substitute with x.
3. Take the 2's complement (invert bits) of x, and substitute with x.
4. Add "1" to x, and substitute with x.
5. Append to the data taking x to be the LRC.
6. Convert the message to ASCII characters.

(2) RTU mode

As the error check for the RTU mode, calculate the CRC-16 up to the end of the data from the slave address, and append the resulting 16-bit data to the data in order lower bits then upper bits.

CRC-16 calculation method

By the CRC method, the information to be sent is divided by a generating function, and the information is appended with the remainder and then sent.

Generating function: $X^{16}+X^{15}+X^2+1$

1. Initialize the data of CRC (taken to be x) to (FFFFH).
2. Exclusive-OR the 1st data with x, and substitute with x.
3. Shift x to the right by one bit, and substitute with x.
4. If the shift results in a carry, exclusive-OR the result of (3) with a fixed value (A001H), and substitute with x. If the shift does not result in a carry, go to step 5.
5. Repeat steps 3 and 4 until x is shifted eight times.
6. Exclusive-OR the next data with x, and substitute with x.
7. Repeat steps 3 to 5.
8. Repeat steps 3 to 5 until the last data.
9. Append the data to the message in order lower bits then upper bits taking x to be CRC-16.

5-7 Examples of Messages

(1) ASCII mode

Reading device No.1 FIX mode SV

- Request message from master

Header	Slave address	Function code	Data address	Number of data	Error check LRC	Delimiter
(:)	(01H)	(03H)	(0300H)	(0001H)	(F8H)	(CR• LF)
1	2	2	4	4	2	2

← Number of characters (17)

- Slave response message in normal operation (when FIX mode SV=10.0°C)

Header	Slave address	Function code	Function code	Data	Error check LRC	Delimiter
(:)	(01H)	(03H)	(02H)	(0064H)	(96H)	(CR• LF)
1	2	2	2	4	2	2

← Number of characters (15)

- Slave response message in erroneous operation (when a data item has been mistaken)

Header	Slave address	Function code	Error code	Error check LRC	Delimiter
(:)	(01H)	(83H)	(02H)	(7AH)	(CR•LF)
1	2	2	2	2	2

← Number of characters (11)

In a response message during normal operation, “1” is set to the MSB of the function code (83H). An error code 02H (non-existent data address) is returned as the response message for the error content.

Writing device No.1, FIX mode SV=10.0°C

- Request message from master

Header	Slave address	Function code	Data address	Data	Error check LRC	Delimiter
(:)	(01H)	(06H)	(0300H)	(0064H)	(92H)	(CR•LF)
1	2	2	4	4	2	2

← Number of characters (17)

- Slave response message in normal operation (when FIX mode SV=10.0°C)

Header	Slave address	Function code	Data address	Data	Error check LRC	Delimiter
(:)	(01H)	(06H)	(0300H)	(0064H)	(92H)	(CR•LF)
1	2	2	4	4	2	2

← Number of characters (17)

- Response message on slave in erroneous operation (when a value outside of the range is set)

Header	Slave address	Function code	Error code	Error check LRC	Delimiter
(:)	(01H)	(86H)	(03H)	(76H)	(CR•LF)
1	2	2	2	4	2

← Number of characters (13)

In a response message during occurrence of an error, “1” is set to the MSB of the function code (86H). An error code 03H (value outside of setting range) is returned as the response message for the error content.

(2) RTU mode**Reading device No.1, FIX mode SV**

- Request message from master

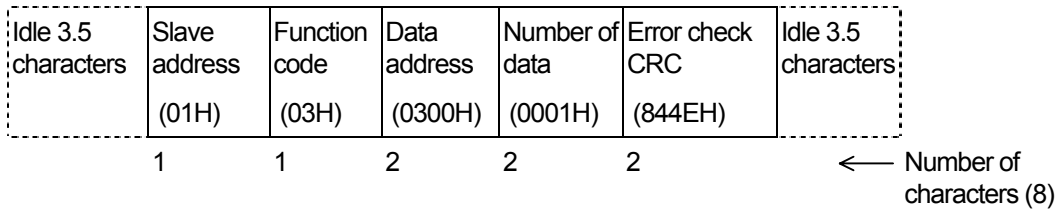

- Slave response message in normal operation (when FIX mode SV=10.0°C)

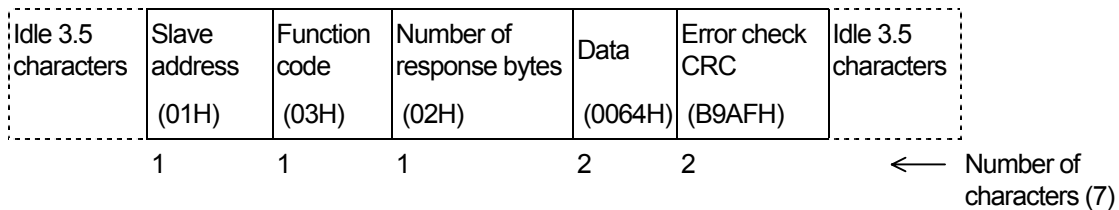

- Slave response message in erroneous operation (when a data item has been mistaken)

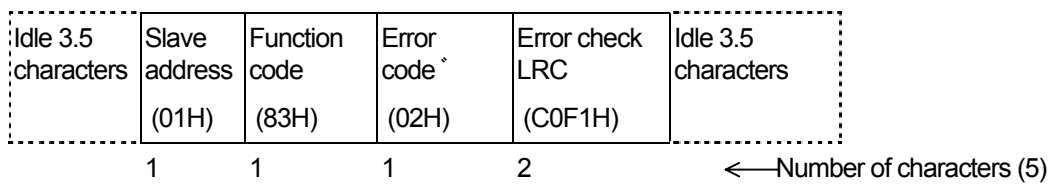

In a response message during normal operation, "1" is set to the MSB of the function code (83H). An error code 02H (non-existent data address) is returned as the response message for the error content.

Setting device No.1, FIX mode SV=10.0°C

- Request message from master

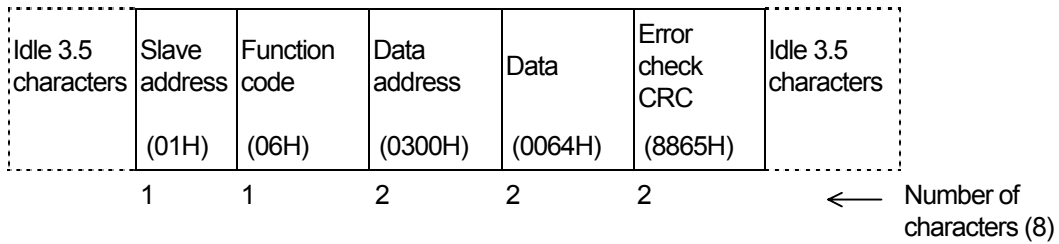

- Slave response message in normal operation (when FIX mode SV=10.0°C)

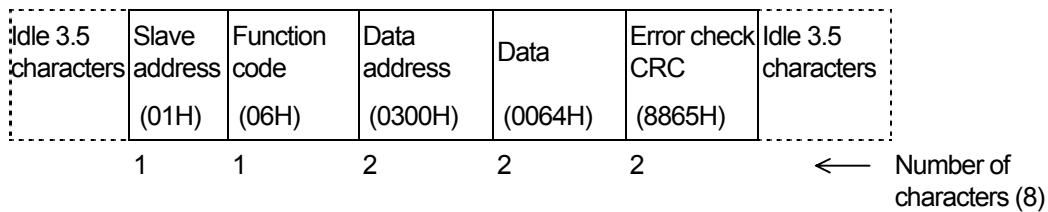

- Response message on slave in erroneous operation (when a value outside of the range is set)

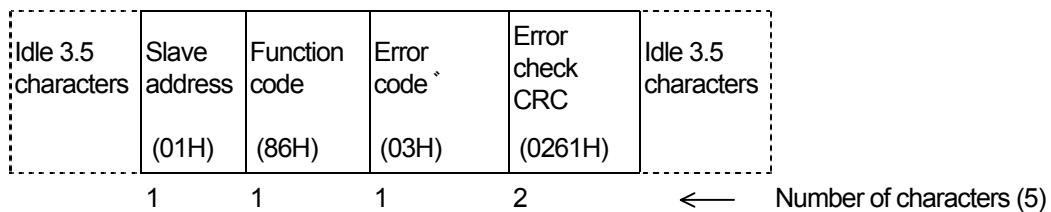

In a response message during occurrence of an error, “1” is set to the MSB of the function code (86H). An error code 03H (value outside of setting range) is returned as the response message for the error content.

This page left intentionally blank

6 LIST OF COMMUNICATION DATA ADDRESSES

6-1 Outline of Communication Data Address

(1) Data address and reading/writing the data address

The data address expresses binary in (16-bit data) 4-bit blocks.

- R/W: Data that can be read and written
- R: Read-only data
- W: Write-only data

When a read-only data address is specified in the Write command (W), a data address error occurs, and the “data format, data address and data number error of the text section” of error response codes “0 (30H)” and “8 (38H)” are returned.

(2) Reading/writing parameters in a 2-loop specification

In a 2-loop specification, the value of the parameter corresponding to each loop can be read by sub-address=1/2 in the case of the SHIMADEN standard protocol, and by slave address=device address/device address+1 in the case4 of the MODBUS communication protocol.

Details of parameters having values for each of these loops are indicated by “T” (support of sub-address) at the right edge of the communication addresses shown below.

(3) Reading/writing “reserved” in the parameter section

When an address not in the list or address indicated as “<reserved>” are read by the Read command (R), “0000H” is returned.

When a part indicated as “<reserved>” is written by the write (W) command, the normal response codes “0 (30H)” and “0 (30H)” are returned. Data, however, is not rewritten.

(4) Reading/writing option-related parameters

When the data address of parameters for unmounted options are specified, the “specification, option error” of error response codes “0 (30H)” and “C (43H)” are returned for both the Read command (R) and Write command (W).

(5) Parameters not displayed on the front panel

Even parameters that are not indicated (used) on the front panel display can be read/written by communication depending on the operation and setup specifications.

(6) Handling data

As each data is binary (16-bit data) without a decimal point, the data type and presence of a decimal point must be checked.

For details of this, refer to the Instruction Manual for this device.

Ex: How to express data with a decimal point

		Hex data
20.0%	200 →	00C8
100.00°C	10000 →	2710
-40.00°C	-4000 →	F060

For the data of unit UNIT, the decimal point position is determined by the measuring range.

Otherwise, data is handled as signed binary (16-bit data: -32768 to 32767).

Logic/logic operation cause parameters

With the logic/logic operation cause, binary 16-bit data is expressed by two data items for a single address, divided into the upper 8 bits and the lower 8 bits.

Ex: EV1 logic 1: 01H (INV)
Logic operation cause 1: 08H (TS8)

Address	Upper 8 bits	Upper 8 bits	Data
0380	01H	TS8	08H

Likewise, the channel information/operation mode of EV1 to 3 and DO1 to 13 are expressed as two data items for a single address.

(7) Execution of broadcast

In the SHIMADEN standard protocol, use the “B” command.

In the MODBUS communication protocol, set “0” to the slave address.

Parameters that can be broadcast are indicated by “B” (broadcast) at the right edge of the communication addresses show below.

(8) Annotation of time data

For details of how time data (hours/mins/secs) is annotated, refer to the following example:

Ex: 1 sec 00: 01 → 0x0001 59 secs 00: 59 → 0x0059
1 hour 01: 00 → 0x0100 99 hours 59 mins 99:59 → 0x9959

60 secs (0x0060) will result in a write error.

6-2 Communication Data Address

Data Addr. (Hex)	Parameter	Setting Range	R/W	T/B
0040	S_CODE1	Series code 1 "F", "P"	R	-
0041	S_CODE2	Series code 2 "2", "3"	R	-
0042	S_CODE3	Series code 3	R	-
0043	S_CODE4	Series code 4	R	-

0100	PV_W	PV value : Within measuring range	R	T
0101	SV_W	Execution SV value : Within setting value limiter	R	T
0102	OUT1_W	Control output 1 : -5.0 to 105.0%	R	-
0103	OUT2_W	Control output 2 : -5.0 to 105.0%	R	-
0104	EXE_FLG	Operation flag (See the detailed explanation below.)	R	T
0105	EV_FLG	Event output flag (See the detailed explanation below.)	R	-
0107	EXE_PID	Execution PID No.: 0 (PID No..1) to 9 (PID No.10)	R	T
0109	HB_W	HB current value (current at output ON) 0.0 to 55.0A	R	-
010A	HL_W	HL current value (current at output OFF) 0.0 to 55.0A	R	-
010B	DI_FLG	DI input state flag (See the detailed explanation below.)	R	-

- | | |
|--------------------------|--------|
| <i>Sc.HH,CU.HH,b----</i> | =7FFFH |
| <i>Sc.LL,CU.LL</i> | =8000H |

The HBL and HLA display is ----. HB current value when output is OFF, and HL current value when output is ON

=7FFEh

- The table below shows the details of the operation flag, Even output flag and the DI input state flag (EXE_FLG, EV_FLG, DI_FLG).
(during no action: bit=0, during action: bit=1)

	D15	D14	D13	D12	D11	D10	D9	D8	D7	D6	D5	D4	D3	D2	D1	D0
EXE_FLG	0	0	0	0	Z/S	0	AT WAIT	COM	0	0	0	0	0	0	MAN	AT
EV_FLG	DO13	DO12	DO11	DO10	DO9	DO8	DO7	DO6	DO5	DO4	DO3	DO2	DO1	EV3	EV2	EV1
DI_FLG	0	0	0	0	0	0	DI10	DI9	DI8	DI7	DI6	DI5	DI4	DI3	DI2	DI1

Data Addr. (Hex)	Parameter	Setting Range	R/W	T/B
0110	UNIT	Measurement unit 0:°C 1:°F 2:% 3:K 4:NONE	R	T
0111	RANGE	Measuring range 0 to 19: Thermocouple 31 to 58: Resistor 71 to 77: Voltage mV 81 to 87: Voltage V (See "7-1 Setting Range Code Table.")	R	T
0112	CJ	Cold junction compensation 0: Internal 1: External	R	T
0113	DP	PV decimal point position 0: XXXXX 1: XXXX.X 2: XXX.XX 3: XX.XXX 4: X.XXXX	R	T
0114	SC_L	PV scaling lower/upper limit At linear input: -19999 to 30000Unit At resistor, thermocouple input: Measuring range is displayed.	R	T
0115	SC_H		R	T
0116	DPFLG	Number of digits past decimal point 0: Normal 1: Short	R	T

0120	E_PRG	Program action flag (See the detailed explanation below.)	R	T
------	-------	---	---	---

- The table below shows the details of the program operation flag.
(during no action: bit=0, during action: bit=1)

	D15	D14	D13	D12	D11	D10	D9	D8	D7	D6	D5	D4	D3	D2	D1	D0
PRG EXE _FLG	PRG	0	0	0	0	UP	LVL	DW	RUN WAIT	0	SO HLD	0	ADV	GUA	HLD	RUN

0121	E_PTN	Program execution pattern No. : 1 to 20	R	T
0122	E_LNK	Program execution link count : 0 to 9999	R	T
0123	E_RPT	Program execution pattern count : 1 to 9999	R	T
0124	E_STP	Program execution step No. : 0 to 400	R	T
0125	E_TIM	Program execution remaining step time : 00: 01 to 99:59	R	T
0126	E_PID	Program execution PID No. : 0 to 10	R	T
0129	E_STPRPT	Program execution step count : 1 to 9999	R	T

- The above seven parameters return 7FFE excluding when E_PRG is in the program mode and in a RUN state.

0141	DES	Servo target opening value (enabled when feedback is ON)		
0142	POSI	Servo opening value (enabled when feedback is ON) : 0 to 100	R	-

Data Addr. (Hex)	Parameter	Setting Range	R/W	T/B
0182	OUT1_W	Control system output 1/2 (possible only in MAN mode) : 0.0 to 100.0%	W	-
0183	OUT2_W		W	-
0184	AT	Auto tuning execution 0: OFF 1: ON	W	T/B
0185	MAN	Manual operation 0: OFF 1: ON	W	T/B
018C	COM	Communication mode 0: LOC 1: COM	W	B
018D	COMDI	EV1-3, DO1-13 direct control	W	B

- When the operation mode is set to LOGIC for EV1 to 3 and DO1 to 3, and to DIRECT for DO6 to 15, the output values of EV1 to 3 and DO1 to 15 can be controlled directly by writing to COMDI.

When another logic operation cause is set for EV1 to 3 and DO1 to 3, these outputs are ORed.

- The table below shows the details of the COMDI data.
(during no action: bit=0, during action: bit=1)

	D15	D14	D13	D12	D11	D10	D9	D8	D7	D6	D5	D4	D3	D2	D1	D0
COMDI_FLG	DO13	DO12	DO11	DO10	DO9	DO8	DO7	DO6	DO5	DO4	DO3	DO2	DO1	EV3	EV2	EV1

0190	RUN/RST	Program reset 0: RESET 1: RUN	W	T/B
0191	HLD	Program hold 0: OFF 1: ON	W	T/B
0192	ADV	Program Advance 0: OFF 1: ON	W	T/B

0244	AT	Auto tuning execution (CH1/CH2 simultaneous) 0: OFF 1: ON	W	B
0245	MAN	Manual operation (CH1/CH2 simultaneous) 0: OFF 1: ON	W	B
0250	RUN/RST	Program reset (CH1/CH2 simultaneous) 0: RESET 1: RUN	W	B
0251	HLD	Program hold (CH1/CH2 simultaneous) 0: OFF 1: ON	W	B
0252	ADV	Program Advance (CH1/CH2 simultaneous) 0: OFF 1: ON	W	B

0280	PV1	CH1 measuring range: Within measuring range	R	-
0281	PV2	CH2 measuring range: Within measuring range	R	-

0300	FIX_SV	FIX mode SV value : Within SV limiter setting range	R/W	T
030A	SV_L	Lower limit SV value setting limiter : Within measuring range (note that SV Limit_L<SV Limit_H)	R/W	T
030B	SV_H	Upper limit SV value setting limiter : Within measuring range (note that SV Limit_L<SV Limit_H)	R/W	T

Data Addr. (Hex)	Parameter	Setting Range	R/W	T/B
0380	EV1_LSRC/LOG1	EV1 logic 1/logic operation cause1 Logic 1 (upper 8 bits) 0: BUF 1: INV 2: FF Logic operation cause1 (lower 8 bits) 0: None 1: TS1 2: TS2 3: TS3 4: TS4 5: TS5 6: TS6 7: TS7 8: TS8 9: TS1-C2 10: TS2-C2 11: TS3-C2 12: TS4-C2 13: TS5-C2 14: TS6-C2 15: TS7-C2 16: TS8-C2 17: DI1 18: DI2 19: DI3 20: DI4 21: DI5 22: DI6 23: DI7 24: DI8 25: DI9 26: DI10	R/W	-
0381	EV1_LSRC/LOG2	EV1 logic 2/logic operation cause2 (same as above)	R/W	-
0382	EV1_LMD	EV1 logic operation mode 0: AND 1: OR 2: XOR	R/W	-
0384	EV2_LSRC/LOG1	EV2 logic 1/logic operation cause1 (same as above)	R/W	-
0385	EV2_LSRC/LOG2	EV2 logic 2/logic operation cause2 (same as above)	R/W	-
0386	EV2_LMD	EV2 logic operation mode 0: AND 1: OR 2: XOR	R/W	-
0388	EV3_LSRC/LOG1	EV3logic 1/logic operation cause1 (same as above)	R/W	-
0389	EV3_LSRC/LOG2	EV3logic 2/logic operation cause2 (same as above)	R/W	-
038A	EV3_LMD	EV3 logic operation mode 0: AND 1: OR 2: XOR	R/W	-
038C	DO1_LSRC/LOG1	DO1logic 1/logic operation cause1 (same as above)	R/W	-
038D	DO1_LSRC/LOG2	DO1logic 2/logic operation cause2 (same as above)	R/W	-
038E	DO1_LMD	DO1 logic operation mode 0: AND 1: OR 2: XOR	R/W	-
0390	DO2_LSRC/LOG1	DO2logic 1/logic operation cause1 (same as above)	R/W	-
0391	DO2_LSRC/LOG2	DO2logic 2/logic operation cause2 (same as above)	R/W	-
0392	DO2_LMD	DO2 logic operation mode 0: AND 1: OR 2: XOR	R/W	-
0394	DO3_LSRC/LOG1	DO3logic 1/logic operation cause1 (same as above)	R/W	-
0395	DO3_LSRC/LOG2	DO3logic 2/logic operation cause2 (same as above)	R/W	-
0396	DO3_LMD	DO3 logic operation mode 0: AND 1: OR 2: XOR	R/W	-
0398	DO4_SRC1	DO4 logic operation cause	R/W	-
039A	DO4_LMD	DO4 logic operation mode 0: Timer 1: Counter	R/W	-
039B	DO4_LTM	DO4 logic operation counter OFF, 1 to 5000s	R/W	-
039C	DO5_SRC1	DO5 logic operation cause	R/W	-
039E	DO5_LMD	DO5 logic operation mode 0: Timer 1: Counter	R/W	-
039F	DO5_LTM	DO5 logic operation counter OFF, 1 to 5000s	R/W	-

Data Addr. (Hex)	Parameter	Setting Range		R/W	T/B
0400	PB1	PID01-OUT1	Proportional band: 0.0 to 999.9% (0.0=OFF)	RW	-
0401	IT1		Integral time: 0 to 6000Sec (0=OFF)	RW	-
0402	DT1		Derivative time: 0 to 3600Sec (0=OFF)	RW	-
0403	MR1		Manual reset: -50.0 to 50.0%	RW	-
0404	DF1		Hysteresis: 1 to 9999 Unit	RW	-
0405	O11_L		Output lower limit: 0.0 to 100.0%	RW	-
0406	O11_H		Output upper limit: 0.0 to 100.0%	RW	-
0407	SF1		Target value function: 0.00 to 1.00	RW	-
0408	PB2	PID02-OUT1	Same as above	RW	-
0409	IT2			RW	-
040A	DT2			RW	-
040B	MR2			RW	-
040C	DF2			RW	-
040D	O12_L			RW	-
040E	O12_H			RW	-
040F	SF2			RW	-
0410	PB3	PID03-OUT1	Same as above	RW	-
0411	IT3			RW	-
0412	DT3			RW	-
0413	MR3			RW	-
0414	DF3			RW	-
0415	O13_L			RW	-
0416	O13_H			RW	-
0417	SF3			RW	-
0418	PB4	PID04-OUT1	Same as above	RW	-
0419	IT4			RW	-
041A	DT4			RW	-
041B	MR4			RW	-
041C	DF4			RW	-
041D	O14_L			RW	-
041E	O14_H			RW	-
041F	SF4			RW	-

Data Addr. (Hex)	Parameter	Setting Range		R/W	T/B
0420	PB5	PID05-OUT1	Proportional band: 0.0 to 999.9% (0.0=OFF)	R/W	-
0421	IT5		Integral time: 0 to 6000Sec (0=OFF)	R/W	-
0422	DT5		Derivative time: 0 to 3600Sec (0=OFF)	R/W	-
0423	MR5		Manual reset: -50.0 to 50.0%	R/W	-
0424	DF5		Hysteresis: 1 to 9999 Unit	R/W	-
0425	O15_L		Output lower limit: 0.0 to 100.0%	R/W	-
0426	O15_H		Output upper limit: 0.0 to 100.0%	R/W	-
0427	SF5		Target value function: 0.00 to 1.00	R/W	-
0428	PB6	PID06-OUT1	Same as above	R/W	-
0429	IT6			R/W	-
042A	DT6			R/W	-
042B	MR6			R/W	-
042C	DF6			R/W	-
042D	O16_L			R/W	-
042E	O16_H			R/W	-
042F	SF6			R/W	-
0430	PB7	PID07-OUT1	Same as above	R/W	-
0431	IT7			R/W	-
0432	DT7			R/W	-
0433	MR7			R/W	-
0434	DF7			R/W	-
0435	O17_L			R/W	-
0436	O17_H			R/W	-
0437	SF7			R/W	-
0438	PB8	PID08-OUT1	Same as above	R/W	-
0439	IT8			R/W	-
043A	DT8			R/W	-
043B	MR8			R/W	-
043C	DF8			R/W	-
043D	O18_L			R/W	-
043E	O18_H			R/W	-
043F	SF8			R/W	-

Data Addr. (Hex)	Parameter	Setting Range		R/W	T/B
0440	PB9	PID09-OUT1	Proportional band: 0.0 to 999.9% (0.0=OFF)	R/W	-
0441	IT9		Integral time: 0 to 6000Sec (0=OFF)	R/W	-
0442	DT9		Derivative time: 0 to 3600Sec (0=OFF)	R/W	-
0443	MR9		Manual reset: -50.0 to 50.0%	R/W	-
0444	DF9		Hysteresis: 1 to 9999 Unit	R/W	-
0445	O19_L		Output lower limit: 0.0 to 100.0%	R/W	-
0446	O19_H		Output upper limit: 0.0 to 100.0%	R/W	-
0447	SF9		Target value function: 0.00 to 1.00	R/W	-
0448	PB10	PID10-OUT1	Same as above	R/W	-
0449	IT10			R/W	-
044A	DT10			R/W	-
044B	MR10			R/W	-
044C	DF10			R/W	-
044D	O10_L			R/W	-
044E	O10_H			R/W	-
044F	SF10			R/W	-
0460	PB21	PID02-OUT1	Proportional band: 0.0 to 999.9% (0.0=OFF)	R/W	-
0461	IT21		Integral time: 0 to 6000Sec (0=OFF)	R/W	-
0462	DT21		Derivative time: 0 to 3600Sec (0=OFF)	R/W	-
0463	MR21/DB21		Manual reset : -50.0 to 50.0% Dead band: -199999 to 20000UNIT	R/W	-
0464	DF21		Hysteresis: 1 to 9999 Unit	R/W	-
0465	O21_L		Output lower limit: 0.0 to 100.0%	R/W	-
0466	O21_H		Output upper limit: 0.0 to 100.0%	R/W	-
0467	SF21		Target value function: 0.00 to 1.00	R/W	-
0468	PB22	PID02-OUT2	Same as above	R/W	-
0469	IT22			R/W	-
046A	DT22			R/W	-
046B	MR22/DB22			R/W	-
046C	DF22			R/W	-
046D	O22_L			R/W	-
046E	O22_H			R/W	-
046F	SF22			R/W	-

Data Addr. (Hex)	Parameter	Setting Range		R/W	T/B
0470	PB23	PID03-OUT2	Proportional band: 0.0 to 999.9% (0.0=OFF)	R/W	-
0471	IT23		Integral time: 0 to 6000Sec (0=OFF)	R/W	-
0472	DT23		Derivative time: 0 to 3600Sec (0=OFF)	R/W	-
0473	MR23/DB23		Manual reset : -50.0 to 50.0% Dead band: -199999 to 20000UNIT	R/W	-
0474	DF23		Hysteresis: 1 to 9999 Unit	R/W	-
0475	O23_L		Output lower limit: 0.0 to 100.0%	R/W	-
0476	O23_H		Output upper limit: 0.0 to 100.0%	R/W	-
0477	SF23		Target value function: 0.00 to 1.00	R/W	-
0478	PB24		PID04-OUT2	Same as above	R/W
0479	IT24	R/W			-
047A	DT24	R/W			-
047B	MR24/DB24	R/W			-
047C	DF24	R/W			-
047D	O24_L	R/W			-
047E	O24_H	R/W			-
047F	SF24	R/W			-
0480	PB25	PID05-OUT2	Same as above	R/W	-
0481	IT25			R/W	-
0482	DT25			R/W	-
0483	MR25/DB25			R/W	-
0484	DF25			R/W	-
0485	O25_L			R/W	-
0486	O25_H			R/W	-
0487	SF25			R/W	-
0488	PB26	PID06-OUT2	Same as above	R/W	-
0489	IT26			R/W	-
048A	DT26			R/W	-
048B	MR26/DB26			R/W	-
048C	DF26			R/W	-
048D	O26_L			R/W	-
048E	O26_H			R/W	-
048F	SF26			R/W	-

Data Addr. (Hex)	Parameter	Setting Range		R/W	T/B
0490	PB27	PID07-OUT2	Proportional band: 0.0 to 999.9% (0.0=OFF)	R/W	-
0491	IT27		Integral time: 0 to 6000Sec (0=OFF)	R/W	-
0492	DT27		Derivative time: 0 to 3600Sec (0=OFF)	R/W	-
0493	MR27/DB27		Manual reset : -50.0 to 50.0% Dead band: -199999 to 20000UNIT	R/W	-
0494	DF27		Hysteresis: 1 to 9999 Unit	R/W	-
0495	O27_L		Output lower limit: 0.0 to 100.0%	R/W	-
0496	O27_H		Output upper limit: 0.0 to 100.0%	R/W	-
0497	SF27		Target value function: 0.00 to 1.00	R/W	-
0498	PB28	PID08-OUT2	Same as above	R/W	-
0499	IT28			R/W	-
049A	DT28			R/W	-
049B	MR28/DB28			R/W	-
049C	DF28			R/W	-
049D	O28_L			R/W	-
049E	O28_H			R/W	-
049F	SF28			R/W	-
04A0	PB29	PID09-OUT2	Same as above	R/W	-
04A1	IT29			R/W	-
04A2	DT29			R/W	-
04A3	MR29/DB29			R/W	-
04A4	DF29			R/W	-
04A5	O29_L			R/W	-
04A6	O29_H			R/W	-
04A7	SF29			R/W	-
04A8	PB210	PID10-OUT2	Same as above	R/W	-
04A9	IT210			R/W	-
04AA	DT210			R/W	-
04AB	MR210/DB210			R/W	-
04AC	DF210			R/W	-
04AD	O210_L			R/W	-
04AE	O210_H			R/W	-
04AF	SF210			R/W	-

Data Addr. (Hex)	Parameter	Setting Range	R/W	T/B
04C0	ZSP1	CH1 side No.1 PID zone: Within measuring range	R/W	-
04C1	ZSP2	CH1 side No.2 PID zone: Within measuring range	R/W	-
04C2	ZSP3	CH1 side No.3 PID zone: Within measuring range	R/W	-
04C3	ZSP4	CH1 side No.4 PID zone: Within measuring range	R/W	-
04C4	ZSP5	CH1 side No.5 PID zone: Within measuring range	R/W	-
04C5	ZSP6	CH1 side No.6 PID zone: Within measuring range	R/W	-
04C6	ZSP7	CH1 side No.7 PID zone: Within measuring range	R/W	-
04C7	ZSP8	CH1 side No.8 PID zone: Within measuring range	R/W	-
04C8	ZSP9	CH1 side No.9 PID zone: Within measuring range	R/W	-
04C9	ZSP10	CH1 side No.10 PID zone: Within measuring range	R/W	-
04CA	ZHYS	CH1 zone hysteresis: 0 to 10000 Unit	R/W	-
04CB	ZPID	CH1 zone PID mode 0: OFF 1: SV 2: PV	R/W	-
04CC	ZSP21	CH2 side No.1 PID zone: Within measuring range	R/W	-
04CD	ZSP22	CH2 side No.2 PID zone: Within measuring range	R/W	-
04CE	ZSP23	CH2 side No.3 PID zone: Within measuring range	R/W	-
04CF	ZSP24	CH2 side No.4 PID zone: Within measuring range	R/W	-
04D0	ZSP25	CH2 side No.5 PID zone: Within measuring range	R/W	-
04D1	ZSP26	CH2 side No.6 PID zone: Within measuring range	R/W	-
04D2	ZSP27	CH2 side No.7 PID zone: Within measuring range	R/W	-
04D3	ZSP28	CH2 side No.8 PID zone: Within measuring range	R/W	-
04D4	ZSP29	CH2 side No.9 PID zone: Within measuring range	R/W	-
04D5	ZSP210	CH2 side No.10 PID zone: Within measuring range	R/W	-
04D6	ZHYS2	CH2 zone hysteresis: 0 to 10000 Unit	R/W	-
04D7	ZPID2	zone PID mode 0: OFF 1: SV 2: PV	R/W	-

Data Addr. (Hex)	Parameter	Setting Range		R/W	T/B
0500	EV1_MD	Event1	CH information/operation mode Channel information (upper 8 bits) 0: CH1 1: CH2 Operation mode (lower 8 bits) 0: None 1: DEV Hi 2: DEV Low 3: DEV Out 4: DEV In 5: PV Hi 6: PV Low 7: S0 8: FIX 9: AT 10: MAN 11: LOGIC 12: RUN 13: HLD 14: GUA 15: STEP 16: PRG.END 17: TS1 18: TS2 19: TS3 20: TS4 21: TS5 22: TS6 23: TS7 24: TS8 25: Posi.H 26: Posi.L 27: LP.ERR 28: HBA 29: HBL	R/W	-
0502	EV1_DF		Hysteresis 1 to 9999 Unit 1 to 50% (26 and 27 above)	R/W	-
0503	EV1_STB		Standby action 0: OFF 1: 1 2: 2 3: 3	R/W	-
0504	EV1_TM		Delay time 0 to 9999Sec (0=OFF)	R/W	-
0505	EV1_CHR		Output characteristics 0: N.O. 1: N.C.	R/W	-
0508	EV2_MD	Event2	Same as above	R/W	-
050A	EV2_DF			R/W	-
050B	EV2_STB			R/W	-
050C	EV2_TM			R/W	-
050D	EV2_CHR			R/W	-
0510	EV3_MD	Event3	Same as above	R/W	-
0512	EV3_DF			R/W	-
0513	EV3_STB			R/W	-
0514	EV3_TM			R/W	-
0515	EV3_CHR			R/W	-

Data Addr. (Hex)	Parameter	Setting Range		R/W	T/B
0518	DO1_MD	DO1	CH information/operation mode Channel information (upper 8 bits) 0: CH1 1: CH2 Operation mode (lower 8 bits) 0: None 1: DEV Hi 2: DEV Low 3: DEV Out 4: DEV In 5: PV Hi 6: PV Low 7: S0 8: FIX 9: AT 10: MAN 11: LOGIC 12: RUN 13: HLD 14: GUA 15: STEP 16: PRG.END 17: TS1 18: TS2 19: TS3 20: TS4 21: TS5 22: TS6 23: TS7 24: TS8 25: Posi.H 26: Posi.L 27: LP.ERR 28: HBA 29: HBL	R/W	-
051A	DO1_DF		Hysteresis 1 to 9999 Unit 1 to 50% (26 and 27 above)	R/W	-
051B	DO1_STB		Standby operation 0: OFF 1: 1 2: 2 3: 3	R/W	-
051C	DO1_TM		Delay time 0 to 9999Sec (0=OFF)	R/W	-
051D	DO1_CHR		Output characteristics 0: N.O. 1: N.C.	R/W	-
0520	DO2_MD	DO2	Same as above	R/W	-
0522	DO2_DF			R/W	-
0523	DO2_STB			R/W	-
0524	DO2_TM			R/W	-
0525	DO2_CHR			R/W	-
0528	DO3_MD	DO3	Same as above	R/W	-
052A	DO3_DF			R/W	-
052B	DO3_STB			R/W	-
052C	DO3_TM			R/W	-
052D	DO3_CHR			R/W	-
0530	DO4_MD	DO4	Same as above	R/W	-
0532	DO4_DF			R/W	-
0533	DO4_STB			R/W	-
0534	DO4_TM			R/W	-
0535	DO4_CHR			R/W	-

Data Addr. (Hex)	Parameter	Setting Range		R/W	T/B
0538	DO5_MD	DO5	CH information/operation mode Channel information (upper 8 bits) 0: CH1 1: CH2 Operation mode (lower 8 bits) 0: None 1: DEV Hi 2: DEV Low 3: DEV Out 4: DEV In 5: PV Hi 6: PV Low 7: S0 8: FIX 9: AT 10: MAN 11: LOGIC 12: RUN 13: HLD 14: GUA 15: STEP 16: PRG.END 17: TS1 18: TS2 19: TS3 20: TS4 21: TS5 22: TS6 23: TS7 24: TS8 25: Posi.H 26: Posi.L 27: LP.ERR 28: HBA 29: HBL	R/W	-
053A	DO5_DF		Hysteresis 1 to 9999 Unit 1 to 50% (26 and 27 above)	R/W	-
053B	DO5_STB		Standby action 0: OFF 1: 1 2: 2 3: 3	R/W	-
053C	DO5_TM		Delay time 0 to 9999Sec (0=OFF)	R/W	-
053D	DO5_CHR		Output characteristics 0: N.O. 1: N.C.	R/W	-
0540	DO6_MD	DO6	Same as above	R/W	-
0542	DO6_DF			R/W	-
0543	DO6_STB			R/W	-
0544	DO6_TM			R/W	-
0545	DO6_CHR			R/W	-
0548	DO7_MD	DO7	Same as above	R/W	-
054A	DO7_DF			R/W	-
054B	DO7_STB			R/W	-
054C	DO7_TM			R/W	-
054D	DO7_CHR			R/W	-
0550	DO8_MD	DO8	Same as above	R/W	-
0552	DO8_DF			R/W	-
0553	DO8_STB			R/W	-
0554	DO8_TM			R/W	-
0555	DO8_CHR			R/W	-
0558	DO9_MD	DO9	Same as above	R/W	-
055A	DO9_DF			R/W	-
055B	DO9_STB			R/W	-
055C	DO9_TM			R/W	-
055D	DO9_CHR			R/W	-

Data Addr. (Hex)	Parameter	Setting Range		R/W	T/B
0560	DO10_MD	DO10	CH information/operation mode Channel information (upper 8 bits) 0: CH1 1: CH2 Operation mode (lower 8 bits) 0: None 1: DEV Hi 2: DEV Low 3: DEV Out 4: DEV In 5: PV Hi 6: PV Low 7: S0 8: FIX 9: AT 10: MAN 11: LOGIC 12: RUN 13: HLD 14: GUA 15: STEP 16: PRG.END 17: TS1 18: TS2 19: TS3 20: TS4 21: TS5 22: TS6 23: TS7 24: TS8 25: Posi.H 26: Posi.L 27: LP.ERR 28: HBA 29: HBL	R/W	-
0562	DO10_DF		Hysteresis 1 to 9999 Unit 1 to 50% (26 and 27 above)	R/W	-
0563	DO10_STB		Standby action 0: OFF 1: 1 2: 2 3: 3	R/W	-
0564	DO10_TM		Delay time 0 to 9999Sec (0=OFF)	R/W	-
0565	DO10_CHR		Output characteristics 0: N.O. 1: N.C.	R/W	-
0568	DO11_MD	DO11	Same as above	R/W	-
056A	DO11_DF			R/W	-
056B	DO11_STB			R/W	-
056C	DO11_TM			R/W	-
056D	DO11_CHR			R/W	-
0570	DO12_MD	DO12	Same as above	R/W	-
0572	DO12_DF			R/W	-
0573	DO12_STB			R/W	-
0574	DO12_TM			R/W	-
0575	DO12_CHR			R/W	-
0578	DO13_MD	DO13	Same as above	R/W	-
057A	DO13_DF			R/W	-
057B	DO13_STB			R/W	-
057C	DO13_TM			R/W	-
057D	DO13_CHR			R/W	-

Data Addr. (Hex)	Parameter	Setting Range	R/W	T/B
0580	DI1	Channel information (upper 8 bits) 0: CH1 1: CH2 2: CH1+2 Operation mode (lower 8 bits) 1: RUN/RST (fixed)	R/W	-
0581	DI2	Channel information (upper 8 bits) 0: CH1 1: CH2 2: CH1+2 Operation mode (lower 8 bits) 0: None 1: RUN/RST 2: RST 3: HLD 4: ADV 5: FIX 6: MAN 7: LOGIC 12: Preset1 13: Preset2 14: Preset3	R/W	-
0582	DI3	Same as above	R/W	-
0583	DI4	Same as above	R/W	-
0584	DI5	Channel information (upper 8 bits) 0: CH1 1: CH2 2: CH1+2 Operation mode (lower 8 bits) 0: None 1: RUN/RST 2: RST 3: HLD 4: ADV 5: FIX 6: MAN 7: LOGIC 8: PTN2bit 9: PTN3bit 10: PTN4bit 11: PTN5bit	R/W	-
0585	DI6	Channel information (upper 8 bits) 0: CH1 1: CH2 2: CH1+2 Operation mode (lower 8 bits) 0: None 1: RUN/RST 2: RST 3: HLD 4: ADV 5: FIX 6: MAN 7: LOGIC	R/W	-
0586	DI7	Same as above	R/W	-
0587	DI8	Channel information (upper 8 bits) 0: CH1 1: CH2 2: CH1+2 Operation mode (lower 8 bits) 0: None 1: RUN/RST 2: RST 3: HLD 4: ADV 5: FIX 6: MAN 7: LOGIC 8: PTN2bit 9: PTN3bit	R/W	-
0588	DI9	Channel information (upper 8 bits) 0: CH1 1: CH2 2: CH1+2 Operation mode (lower 8 bits) 0: None 1: RUN/RST 2: RST 3: HLD 4: ADV 5: FIX 6: MAN 7: LOGIC	R/W	-
0589	DI10	Same as above	R/W	-

Data Addr. (Hex)	Parameter	Setting Range	R/W	T/B
0590	HBS	Heater burnout alarm 0.0 to 50.0A (0.0=OFF)	R/W	-
0591	HBL	Heater loop alarm 0.0 to 50.0A (0.0=OFF)	R/W	-
0592	HB_MD	Heater burnout mode 0: Lock 1: Real	R/W	-
0597	HB_SEL	HB selection 0: OUT1 1: OUT2	R/W	-
05A0	AO1_MD	Analog output mode 1 0: PV 1: SV 2: DEV 3: OUT1 4: CH2_PV 5: CH2_SV 6: CH2_DEV 7: OUT2 8: Posi	R/W	-
05A1	AO1_L	Analog output 1 scaling	R/W	-
05A2	AO1_H	PV, CH2_PV → Within measuring range SV, CH2_SV → Within SV limiter setting range DEV, CH2_DEV → -100.0 to 100.0% OUT1, OUT2 → 0.0 to 100.0% Note that Ao1 Sc_L ≠ Ao1 Sc_H Posi 0 to 100%	R/W	-
05A4	AO_MD	Same as above	R/W	-
05A5	AO2_L		R/W	-
05A6	AO2_H		R/W	-
05B0	COM MEM	Communication memory mode 0: EEP 1: RAM 2: R_E	R/W	-
0600	ACTMD	Output characteristics (1-output side) 0: Reverse 1: Direct	R/W	-
0601	01_CYC	Output 1 proportional cycle: 1 to 120 Sec	R/W	-
0604	02_CYC	Output 2 proportional cycle: 1 to 120 Sec	R/W	-
0607	ACTMD2	Output characteristics (2-output side) 0: Reverse 1: Direct	R/W	-
0608	OUT1_LMT	Output 1 rate-of-change limiter OFF to 100.0 %/s (OFF: 0.0)	R/W	-
0609	OUT2_LMT	Output 2 rate-of-change limiter OFF to 100.0 %/s (OFF: 0.0)	R/W	-
0610	ATP	Auto tuning points: 0 to 10000 Unit	R/W	T
0611	KLOCK	Key lock 0: OFF 1: LOCK1 2: LOCK2 3: LOCK3	R/W	-
0614	OUT_MD	Output mode selection 0: Single 1: Dual	R/W	-
0619	O1ST_PR	Output 1STBY preset value and error output	R/W	-
061A	ERROUT1	Without servo option mounted -5.0 to 100.0 With servo option mounted (FB OFF) 0: Stop 1: Preset1 2: Preset2 3: Preset3 4: Preset4 5: Preset5 6: Preset6 7: Preset7 With servo option mounted (FB OFF) 0: Stop 1: Close 2: Open	R/W	-
061D	O2ST_PR	Same as above	R/W	-
061E	ERROUT2		R/W	-

Data Addr. (Hex)	Parameter	Setting Range	R/W	T/B
064F	MORTOR_TM	Motor stroke time: 5 to 300 s	R/W	-
0651	SER_FB	Servo feedback 0: OFF 1: ON	R/W	-
0652	SER_DB	Servo dead band: 0.2 to 10.0 %	R/W	-
0654	MAN_ST_DRC	Set position at restart 0: None 1: Close 2: Open	R/W	-
0655	ZS_MD	Zero span adjustment mode 0: Auto 1: Manual	R/W	-
066A	DI_SRv_PRE1	External input opening value preset 1: 0 to 100%	R/W	-
066B	DI_SRv_PRE2	External input opening value preset 2: 0 to 100%	R/W	-
066C	DI_SRv_PRE3	External input opening value preset 3: 0 to 100%	R/W	-
066D	DI_SRv_PRE4	External input opening value preset 4: 0 to 100%	R/W	-
066E	DI_SRv_PRE5	External input opening value preset 5: 0 to 100%	R/W	-
066F	DI_SRv_PRE6	External input opening value preset 6: 0 to 100%	R/W	-
0670	DI_SRv_PRE7	External input opening value preset 7: 0 to 100%	R/W	-

0700	PV_BS1	INPUT 1/2 PV slope: 0.500 to 1.500	R/W	T
0701	PV_B1	INPUT 1/2 PV bias: -10000 to 10000Unit	R/W	T
0702	PV_F1	INPUT 1/2 PV filter: OFF, 1 to 100 (OFF=0)	R/W	T

0706	CJ	Cold junction compensation 0: Internal 1: External	R/W	T
------	----	--	-----	---

070F	SCO_MD	Action at occurrence of scale over: 0/1	R/W	-
------	--------	---	-----	---

- For details, refer to “8-1 Setting by 2-input Operations” in the Instruction Manual.

0714	PV_BS3	INPUT 2 PV slope: 0.500 to 1.500	R/W	-
0715	PV_B3	INPUT 2 PV bias: -10000 to 10000Unit	R/W	-
0716	PV_F3	INPUT 2 PV filter: OFF, 1 to 100 (OFF=0)	R/W	-

- The above three parameters are setting items on the 2-input side in the case of 2-input operations.

Data Addr. (Hex)	Parameter	Setting Range	R/W	T/B
0720	A1	Ten-segment linearizer input 1: -5.00 to 105.00%	R/W	T
0721	B1	Ten-segment linearizer output 1: -5.00 to 105.00%	R/W	T
0722	A2	Ten-segment linearizer input 2: -5.00 to 105.00%	R/W	T
0723	B2	Ten-segment linearizer output 2: -5.00 to 105.00%	R/W	T
0724	A3	Ten-segment linearizer input 3: -5.00 to 105.00%	R/W	T
0725	B3	Ten-segment linearizer output 3: -5.00 to 105.00%	R/W	T
0726	A4	Ten-segment linearizer input 4: -5.00 to 105.00%	R/W	T
0727	B4	Ten-segment linearizer output 4: -5.00 to 105.00%	R/W	T
0728	A5	Ten-segment linearizer input 5: -5.00 to 105.00%	R/W	T
0729	B5	Ten-segment linearizer output 5: -5.00 to 105.00%	R/W	T
072A	A6	Ten-segment linearizer input 6: -5.00 to 105.00%	R/W	T
072B	B6	Ten-segment linearizer output 6: -5.00 to 105.00%	R/W	T
072C	A7	Ten-segment linearizer input 7: -5.00 to 105.00%	R/W	T
072D	B7	Ten-segment linearizer output 7: -5.00 to 105.00%	R/W	T
072E	A8	Ten-segment linearizer input 8: -5.00 to 105.00%	R/W	T
072F	B8	Ten-segment linearizer output 8: -5.00 to 105.00%	R/W	T
0730	A9	Ten-segment linearizer input 9: -5.00 to 105.00%	R/W	T
0731	B9	Ten-segment linearizer output 9: -5.00 to 105.00%	R/W	T
0732	A10	Ten-segment linearizer input 10: -5.00 to 105.00%	R/W	T
0733	B10	Ten-segment linearizer output 10: -5.00 to 105.00%	R/W	T
0734	A11	Ten-segment linearizer input 11: -5.00 to 105.00%	R/W	T
0735	B11	Ten-segment linearizer output 11: -5.00 to 105.00%	R/W	T
0736	APPR	Ten-segment linearizer 0: OFF 1: ON	R/W	T
0737	LCUT	Low cut at linear input: 1.0 to 5.0%	R/W	T
0738	SQRT	Square root operation at low cut 0: OFF 1: ON	R/W	T

Data Addr. (Hex)	Parameter	Setting Range	R/W	T/B
0800	PRG_MD	Program mode 0: PROG 1: FIX	R/W	T
0802	ST_PTIN	Start pattern No.: 1 to 20	R/W	T
0805	LNK_PTIN	Link repeat count: 0 to 9999	R/W	T
0806	Link_01/02	Link information 01-02 upper 8 bits/lower 8 bits	R/W	T
0807	Link_03/04	Link information 03-04 upper 8 bits/lower 8 bits	R/W	T
0808	Link_05/06	Link information 05-06 upper 8 bits/lower 8 bits	R/W	T
0809	Link_07/08	Link information 07-08 upper 8 bits/lower 8 bits	R/W	T
080A	Link_09/10	Link information 09-10 upper 8 bits/lower 8 bits	R/W	T
080B	Link_11/12	Link information 11-12 upper 8 bits/lower 8 bits	R/W	T
080C	Link_13/14	Link information 13-14 upper 8 bits/lower 8 bits	R/W	T
080D	Link_15/16	Link information 15-16 upper 8 bits/lower 8 bits	R/W	T
080E	Link_17/18	Link information 17-18 upper 8 bits/lower 8 bits	R/W	T
080F	Link_19/20	Link information 19-20 upper 8 bits/lower 8 bits	R/W	T

0810	ADV_MD	Advance mode 0: Step 1: Time	R/W	T
0811	ADV_TM	Advance time: 00:00 to 99:59 sec/min	R/W	T

0812	PRG_WAIT	Program execution standby time: 00:00 to 99:59	R/W	T
0813	CH1_PTIN	CH1 number of program patterns: 0 to 20 * It takes about one second to rewrite this parameter. So, attention must be paid when continuously writing parameters.	R/W	-

0819	TIM_MD	Time mode 0: H/M 1: M/S	R/W	T
081A	SHT_MD	Momentary stop mode 0: RESET 1: CONTINUE	R/W	T
081B	SCO_PMD	Input error mode 0: HLD 1: RUN 2: RESET	R/W	T

Data Addr. (Hex)	Parameter	Setting Range	R/W	T/B
0820	FIX_PID	FIX MODE PID No.: 0 to 10	R/W	T
0821	FIX_MOVE	FIX MOVE 0: EXE 1: EXE/STBY 2: EXE/TRCK	R/W	T

0830	FIX_EV1	FIX MODE EV1 action point DEV_Hi, DEV_Low assignment: -25000 to 25000 DEV_Out, DEV_In assignment: 0 to 25000 v_Hi,PV_Low assignment: : Within measuring range	R/W	-
0831	FIX_EV2	Same as above	R/W	-
0832	FIX_EV3	Same as above	R/W	-
0833	FIX_DO1	Same as above	R/W	-
0834	FIX_DO2	Same as above	R/W	-
0835	FIX_DO3	Same as above	R/W	-
0836	FIX_DO4	Same as above	R/W	-
0837	FIX_DO5	Same as above	R/W	-
0838	FIX_DO6	Same as above	R/W	-
0839	FIX_DO7	Same as above	R/W	-
083A	FIX_DO8	Same as above	R/W	-
083B	FIX_DO9	Same as above	R/W	-
083C	FIX_DO10	Same as above	R/W	-
083D	FIX_DO11	Same as above	R/W	-
083E	FIX_DO12	Same as above	R/W	-
083F	FIX_DO13	Same as above	R/W	-

About data of address “0902” onwards

The pattern No. and step No. must be specified to address “0902” onwards for reading and writing/

Before reading/writing data of address “0902” onwards write the pattern No. at address “0900”

Data Addr. (Hex)	Parameter	Setting Range	R/W	T/B
0900	PTN_NO	Pattern No. Note	R/W	-
0901	STP_NO	Step No. Note	R/W	-

Note: Becomes a write to RAM regardless of the memory mode.

0902	P_ST_PTN	Pattern start step No.: Within number of steps range	R/W	-
0903	P_ED_STP	Number of pattern steps * It takes about one second to rewrite this parameter. So, attention must be paid when continuously writing parameters.	R/W	-
0904	Reserved	Reserved		-
0905	P_RTP	Pattern repeat execution count: 1 to 9999	R/W	-
0906	P_ST_SV	Pattern start SV value: Within SV limiter setting range	R/W	-
0907	P_GUA_Z	Pattern guarantee soak zone OFF, 1 to 9999 (OFF=0)	R/W	-
0908	P_GUA_T	Pattern guarantee soak zone time: 00:00 to 99:59 (unit: sec or min)	R/W	-
0909	P_PV_ST	Pattern PV start 0: OFF 1: ON	R/W	-
090A	P_RPT_ST	Pattern repeat start step No.: 1 to number of steps	R/W	-
090B	P_RTP_ED	Pattern repeat end step No.: 1 to number of steps	R/W	-
090C	P_STP_RPT	Pattern loop execution count: 1 to 9999	R/W	-
090D	Reserved	Reserved		-
090E	Reserved	Reserved		-
090F	Reserved	Reserved		-
0910	Reserved	Reserved		-
0911	Reserved	Reserved		-

Data Addr. (Hex)	Parameter	Setting Range	R/W	T/B
0912	P_EV1	Pattern EV1 action point DEV_Hi, DEV_Low assignment: -25000 to 25000 DEV_Out, DEV_In assignment: 0 to 25000 Pv_Hi, PV_Low assignment: : Within measuring range	R/W	-
0913	P_EV2	Same as above	R/W	-
0914	P_EV3	Same as above	R/W	-
0915	P_DO1	Same as above	R/W	-
0916	P_DO2	Same as above	R/W	-
0917	P_DO3	Same as above	R/W	-
0918	P_DO4	Same as above	R/W	-
0919	P_DO5	Same as above	R/W	-
091A	P_DO6	Same as above	R/W	-
091B	P_DO7	Same as above	R/W	-
091C	P_DO8	Same as above	R/W	-
091D	P_DO9	Same as above	R/W	-
091E	P_DO10	Same as above	R/W	-
091F	P_DO11	Same as above	R/W	-
0920	P_DO12	Same as above	R/W	-
0921	P_DO13	Same as above	R/W	-

0922	P_TS1_ST	Pattern time signal 1 ON step No.: OFF, 1 to number of steps (OFF=0)	R/W	-
0923	P_TS1_ED	Pattern time signal 1 OFF step No.: OFF, 1 to number of steps (OFF=0)	R/W	-
0924	P_TS1_ON	Pattern time signal 1 ON time: 00:00 to 99:59 (unit: sec or min)	R/W	-
0925	P_TS1_OFF	Pattern time signal 1 OFF time: 00:00 to 99:59 (unit: sec or min)	R/W	-
0926	P_TS2_ST	Same as above	R/W	-
0927	P_TS2_ED		R/W	-
0928	P_TS2_ON		R/W	-
0929	P_TS2_OFF		R/W	-
092A	P_TS3_ST	Same as above	R/W	-
092B	P_TS3_ED		R/W	-
092C	P_TS3_ON		R/W	-
092D	P_TS3_OFF		R/W	-

Data Addr. (Hex)	Parameter	Setting Range	R/W	T/B
092E	P_TS4_ST	Pattern time signal 4 ON step No.: OFF, 1 to number of steps (OFF=0)	R/W	-
092F	P_TS4_ED	Pattern time signal 4 OFF step No.: OFF, 1 to number of steps (OFF=0)	R/W	-
0930	P_TS4_ON	Pattern time signal 4 ON time: 00:00 to 99:59 (unit: sec or min)	R/W	-
0931	P_TS4_OFF	Pattern time signal 4 OFF time: 00:00 to 99:59 (unit: sec or min)	R/W	-
0932	P_TS5_ST	Same as above	R/W	-
0933	P_TS5_ED		R/W	-
0934	P_TS5_ON		R/W	-
0935	P_TS5_OFF		R/W	-
0936	P_TS6_ST	Same as above	R/W	-
0937	P_TS6_ED		R/W	-
0938	P_TS6_ON		R/W	-
0939	P_TS6_OFF		R/W	-
093A	P_TS7_ST	Same as above	R/W	-
093B	P_TS7_ED		R/W	-
093C	P_TS7_ON		R/W	-
093D	P_TS7_OFF		R/W	-
093E	P_TS8_ST	Same as above	R/W	-
093F	P_TS8_ED		R/W	-
0940	P_TS8_ON		R/W	-
0941	P_TS8_OFF		R/W	-

0950	STEP_SV	Step SV value: : Within measuring range	R/W	-
0951	STEP_TM	Step time: 00:00 to 99:59 (unit: sec or min)	R/W	-
0952	STEP_PID	Step PID No.: 0 to 10	R/W	-

This page left intentionally blank

7 APPENDIX

7-1 Setting Range Code Table

Code	Code	Measurement Range	Measurement Range
01	B	0.0 to 1800.0°C	0 to 3300°F
02	R	0.0 to 1700.0°C	0 to 3100°F
03	S	0.0 to 1700.0°C	0 to 3100°F
04	K1	-100.0 to 400.0°C	-150.0 to 750.0°F
05	K2	0.0 to 400.0°C	0.0 to 750.0°F
06	K3	0.0 to 800.0°C	0.0 to 1500.0°F
07	K4	0.0 to 1370.0°C	0.0 to 2500.0°F
08	K5	-200.0 to 200.0°C	-300.0 to 400.0°F
09	E	0.0 to 700.0°C	0.0 to 1300.0°F
10	J	0.0 to 600.0°C	0.0 to 1100.0°F
11	T	-200.0 to 200.0°C	-300.0 to 400.0°F
12	N	0.0 to 1300.0°C	0.0 to 2300.0°F
13	PL II	0.0 to 1300.0°C	0.0 to 2300.0°F
14	PR40-20	0.0 to 1800.0°C	0 to 3300°F
15	WRe5-26	0.0 to 2300.0°C	0 to 4200°F
16	U	-200.0 to 200.0°C	-300.0 to 400.0°F
17	L	0.0 to 600.0°C	0.0 to 1100.0°F
18	K	10.0 to 350.0 K	10.0 to 350.0 K
19	AuFe-Cr	0.0 to 350.0 K	0.0 to 350.0 K
31	Pt1	-200.0 to 600.0°C	-300.0 to 1100.0°F
32	Pt2	-100.00 to 100.00°C	-150.0 to 200.0°F
33	Pt3	-100.0 to 300.0°C	-150.0 to 600.0°F
34	Pt4	-60.00 to 40.00°C	-80.00 to 100.00°F
35	Pt5	-50.00 to 50.00°C	-60.00 to 120.00°F
36	Pt6	-40.00 to 60.00°C	-40.00 to 140.00°F
37	Pt7	-20.00 to 80.00°C	0.00 to 180.00°F
38	Pt8	0.000 to 30.000°C	0.00 to 80.00°F
39	Pt9	0.00 to 50.00°C	0.00 to 120.00°F
40	Pt10	0.00 to 100.00°C	0.00 to 200.00°F
41	Pt11	0.00 to 200.00°C	0.0 to 400.0°F
42	Pt12	0.00 to 300.0°C	0.0 to 600.0°F
43	Pt13	0.0 to 300.0°C	0.0 to 600.0°F
44	Pt14	0.0 to 500.0°C	0.0 to 1000.0°F

45	JPt1	-200.0 to 500.0°C	-300.0 to 900.0°F
46	JPt2	-100.00 to 100.00°C	-150.0 to 200.0°F
47	JPt3	-100.0 to 300.0°C	-150.0 to 600.0°F
48	JPt4	-60.00 to 40.00°C	-80.00 to 100.00°F
49	JPt5	-50.00 to 50.00°C	-60.00 to 120.00°F
50	JPt6	-40.00 to 60.00°C	-40.00 to 140.00°F
51	JPt7	-20.00 to 80.00°C	0.00 to 180.00°F
52	JPt8	0.000 to 30.000°C	0.00 to 80.00°F
53	JPt9	0.00 to 50.00°C	0.00 to 120.00°F
54	JPt10	0.00 to 100.00°C	0.00 to 200.00°F
55	JPt11	0.00 to 200.00°C	0.0 to 400.0°F
56	JPt12	0.00 to 300.0°C	0.0 to 600.0°F
57	JPt13	0.0 to 300.0°C	0.0 to 600.0°F
58	JPt14	0.0 to 500.0°C	0.0 to 900.0°F
71	-10 to 10 mV		
72	0 to 10 mV		
73	0 to 20 mV		
74	0 to 50 mV		
75	10 to 50 mV		
76	0 to 100 mV		
77	-100 to 100 mV		
81	-1 to 1 V		
82	0 to 1 V		
83	0 to 2 V		
84	0 to 5 V		
85	1 to 5 V		
86	0 to 10 V		
87	-10 to 10 V		

7-2 ASCII Code Table

	B7 b6 b5	000	001	010	011	100	101	110	111
b4 to b1		0	1	2	3	4	5	6	7
0000	0	NUL	TC7 (DLE)	SP	0	@	P	`	p
0001	1	TC1 (SOH)	DC1	!	1	A	Q	a	q
0010	2	TC2 (STX)	DC2	"	2	B	R	b	r
0011	3	TC3 (ETX)	DC3	#	3	C	S	c	s
0100	4	TC4 (EOT)	DC4	\$	4	D	T	d	t
0101	5	TC5 (ENQ)	TC8 (NAK)	%	5	E	U	e	u
0110	6	TC6 (ACK)	TC9 (SYN)	&	6	F	V	f	v
0111	7	BEL	TC10 (ETB)	'	7	G	W	g	w
1000	8	FE0 (BS)	CAN	(8	H	X	h	x
1001	9	FE1 (HT)	EM)	9	I	Y	i	y
1010	A	FE2 (LF)	SUB	*	:	J	Z	j	z
1011	B	FE3 (VT)	ESC	+	;	K	[k	{
1100	C	FE4 (FF)	IS4 (FS)	,	<	L	\	l	
1101	D	FE5 (CR)	IS3 (GS)	-	=	M]	m	}
1110	E	SO	IS2 (RS)	.	>	N	^	n	to
1111	F	SI	IS1 (US)	/	?	O	_	o	DEL

This page left intentionally blank

Distributed in New Zealand by:

Intech INSTRUMENTS LTD

Christchurch	Auckland	www.intech.co.nz
Ph: +6433430646	098271930	sales@intech.co.nz
Fx: +6433430649	098271931	

The contents of this Instruction Manual are subject to change without notice.

Temperature and Humidity Control Specialists

SHIMADEN CO., LTD.

<http://www.shimaden.co.jp/>

Head Office: 2-30-10 Kitamachi, Nerima-ku, Tokyo 179-0081 Japan
Phone: (03)3931-7891 Fax: (03)3931-3089 E-mail: exp-dept@shimaden.co.jp

PRINTED IN JAPAN