

**FIELD MOUNTED
BATCH CONTROLLER
MODEL 114D**



CONTENTS

1. Introduction	1
2. Specification	2
3. Operation	4
3.1 Front Panel Operation	4
3.2 Test Mode	6
3.3 Batch Operations	7
3.3.1 Control Outputs	7
3.3.2 Signal Timeout	8
4. Programming	9
4.1 Program Steps	10
4.2 Example	11
5. Valve Control and DC Power	12
6. Battery Backup	14
7. Flowmeter Input	15
8. Installation	20
8.1 Wall Mounting	20
8.2 Removing the Front Panel	21
8.3 The Main Electronics	22
8.4 Wiring	23
8.5 Maintenance	23
8.6 Terminal Designations	23
Index	24

1. INTRODUCTION

The Model 114 Batch Controller is a microprocessor based instrument which accepts a frequency or pulse input from a wide range of flowmeters and automatically controls the batching of fluids via a one stage or two stage control valves. The instrument displays the Preset value, a Resettable Batch Total and an Accumulated Total directly in engineering units.

The Model 114 is fully programmable from the front panel; the user can program scaling factors, decimal point positions, valve delays and signal timeouts.

The instrument is compatible with a wide range of flowmeters. Links on the input board enable the circuit to be configured for millivolt signals, reed switches, Namur proximity switches and most other signal types.

The instrument is housed in an attractive polycarbonate enclosure which is completely watertight. A universal bracket is supplied as standard for wall mounting while optional pipe or panel mounting brackets are also available.

The Model 114 Batch Controller conforms to the EMC-Directive of the Council of European Communities 2014/30/EU, the LVD directive 2014/35/EU and the following standards:

EN61326:2013

Electrical equipment for measurement, control and laboratory use – EMC requirements : Residential, Commercial & Light Industry Environment & Industrial Environment.

EN61010:2010

Safety requirements for electrical equipment for measurement, control, and laboratory use.

In order to comply with these standards, the wiring instructions in Section 9.5 must be adhered to.

2 Specification

2. SPECIFICATION

General

Display:	LCD which is continuously powered.
Batch Total:	7 digits with 10mm (0.4") high digits.
Accumulated Total:	Displayed when the ACCUM TOTAL button is pressed.
Preset:	5 digits with 8.5mm (0.33") high digits.
K-factor:	The pulses per unit of measure (eg. pulses/gallon) is programmable in the range 0.0001 to 999,999.
Decimal Points:	Decimal point position is fully programmable for the total and preset.
Frequency Range:	0Hz to 10kHz.
Signal Type:	Link settable for sinewave (15mV P-P minimum), open collector, reed switch, pulse or Namur proximity switch.
DC Power Input:	9-28 Volt at 4mA maximum.

Battery Backup

Type:	The two Lithium cells are 3.6V, AA types. e.g. TADIRAN SL360/S, SAFT LS14500EX. Note the battery polarity when replacing.
Battery Life:	2 years typical.

Outputs

Outputs:	Two solid state relay outputs suitable for driving DC solenoids or external relays.
Switching Power:	200mA. 30VDC maximum.
Supply Backup:	Lithium battery.
Isolation:	Both outputs are separately isolated via opto-isolators.

Physical

Temperature:	Operating temperature: -20°C to 60°C.
Dimensions:	98mm (3.9") high x 152mm (6.0") wide x 43mm (1.7") deep (cable glands not included).
Protection:	Sealed to Nema 4X or IP67 standards.
Cable Entry:	By cable glands.
Material:	Polycarbonate and ABS.
Wall Mounting:	Universal mounting bracket supplied as standard.

4 Operation

3. OPERATION

The Model 114 Batch Controller accepts a frequency or pulse input from a wide range of flowmeters. The instrument is fully programmable with all operating parameters and calculation constants programmable from the front panel. The setup parameters are stored in a non-volatile memory and are retained for at least 10 years in the event of a power loss.

3.1 FRONT PANEL OPERATION

Three keys on the front of the instrument provide an easy and straight forward method to set up batches and control operations. The three keys each have dual functions as described below:

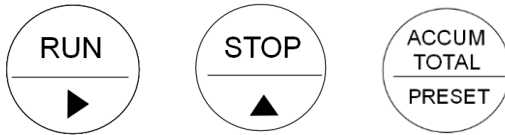

Front Panel Keys

SETTING THE PRESET QUANTITY

The Batch quantity is programmed as follows:

<i>Switch Action</i>	<i>Display</i>	<i>Comments</i>
Press PRESET		The Accumulated Total together with the Preset quantity is displayed.
	"1" 2345	The most significant digit of the Preset quantity flashes indicating that it can be changed.
Press ▲	"2" 2345	Pressing the ▲ key will increment the digit. (The up arrow on the Stop key indicates to increment the digit.)

<i>Switch Action</i>	<i>Display</i>	<i>Comments</i>
Press ►	2 "2" 345	Pressing the ► key will change digit and enables the next digit to be incremented. (The right arrow on the RUN key indicates to change digit.)
Press PRESET	22345	Pressing PRESET returns the instrument to the Run mode and batches can now be run.

Note: If there are no keys pressed within 10 seconds while the instrument is in preset mode it will return to the run mode saving the current value as the preset quantity.

Upon exit of preset mode the value is checked against the programmable batch limit. If the value is greater than the batch limit the preset value is set to the programmed limit. This check is disabled if the batch limit is programmed as zero.

Once programmed, the Preset quantity will be retained in memory and will not alter until changed by the user. The Preset quantity can only be set while the instrument is in a non-operational state such as when the batch is complete, or has been cancelled.

STARTING A BATCH

To start a batch press the RUN key. The Total will then reset to zero and, provided there is flow, the Total display will start counting upwards.

The batcher has two output transistors and these are switched on and off as described in section 3.3.

STOPPING

The process can be stopped at any time by pressing the STOP switch. This is indicated by the "Pause" message being displayed on the screen. Once the process has been interrupted in this way, it can be continued by pressing the RUN key or the process can be aborted by pressing the STOP switch a second time.

6 Operation

ACCUMULATED TOTAL

During a batch run, the Accumulated Total can be displayed by pressing the ACCUM TOTAL key. In the non-operational state (ie. when the batch is complete), the ACCUM TOTAL key also functions as the PRESET key and enables the Preset quantity to be changed.

The Accumulated Total cannot normally be reset, except by pressing the internal Reset button (see section 9.4).

3.2 TEST MODE

The 114 has a Test Mode which can be entered and exited by pressing and holding the front panel keys in certain sequences to avoid accidental entry or falsely starting a batch. To enter Test Mode, the front panel keys should be pressed and held in the following order: the STOP key and then the ACCUM TOTAL key.

Note the test mode cannot be entered while the instrument is in program mode or preset mode.

The tests are as follows:

- | | |
|----------------------------|--|
| <i>Relay 1 Test</i> | By pressing the RUN key, the display will show the test for Relay 1. The output will only activate while the RUN key is being pressed. |
| <i>Relay 2 Test</i> | By pressing the STOP key, the display will show the test for Relay 2. The output will only activate while the STOP key is being pressed. |
| <i>Display Test</i> | By pressing the PROGRAM key, all segments of the display will flash. |

Note the relay outputs are only operated when external DC power is present. And any batch in progress when test mode is entered is stopped and cannot be resumed.

To exit Test Mode, the front panel keys should be pressed and held in the following order: the ACCUM TOTAL key and then the STOP key.

3.3 BATCH OPERATIONS

The operation of the Batch Controller is shown below:

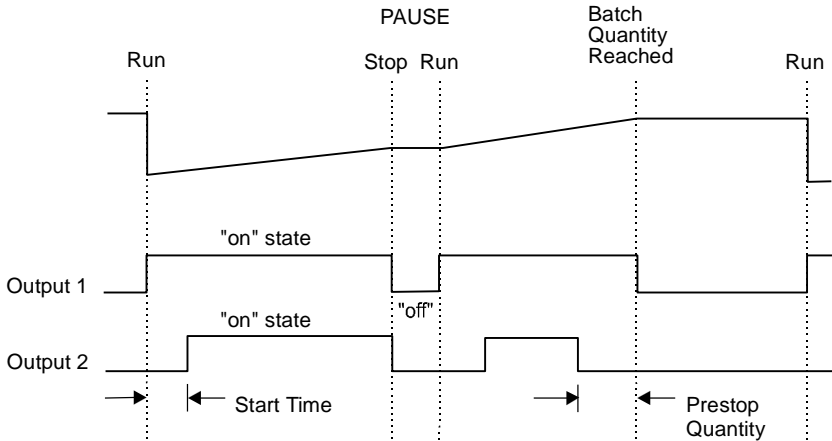

Two Stage Valve Control

3.3.1 Control Outputs

The two solid state relay outputs can be set up to control a single valve or a dual valve with slow stop and/or slow start. Alternatively, the second output can be used to control a pump.

The output operation is shown above.

A time delay between the Start and the time when Output 2 switches on can be programmed to provide a soft startup. The delay can range from 0 (no delay) to 9 seconds.

A Pre-stop quantity (ie. the quantity to the end of the batch) can also be programmed to provide a slowdown of flow at the end of the batch, thereby enabling precise quantities to be batched.

8 Operation

The process can be stopped at any time by pressing the STOP key, whereby both outputs will immediately switch off. The process can then be aborted and the batcher reset by pressing the STOP key again, or the process continued by pressing the RUN key.

If the process is continued and the instrument was previously in the slow start or main control phases (ie. not the pre-stop phase), the timer will be reset and a slow start will occur with a full time delay to ensure a correct start up. The totals will not be reset and the batch quantity will remain unchanged.

3.3.2 Signal Timeout

The Signal Timeout period defines a time interval which is used to detect if the flow has stopped. If there is no signal input for a time greater than the Signal Timeout period, the flow is deemed to have stopped. A Signal Timeout period detects the loss of signal midway through a batch when the outputs are on. In this case, the Batcher will enter a Flow Alarm condition and switch off the outputs.

The Flow Alarm condition is maintained until acknowledged by pressing the STOP switch. The alarm condition is also signalled to the operator by the PAUSE message being flashed on the display.

The instrument enables the user to program a time interval of up to 99 seconds to detect an absence of signal input.

If the Signal Timeout is set to 0, this function is disabled.

4. PROGRAMMING

The Model 114 is fully programmable, with all parameters being stored in memory.

The Program Mode can be entered in one of two ways:

1. By removing the lower cover strip (ie. the dark grey strip along the bottom of the enclosure) and turning it end for end and replacing it. This brings a small magnet, on the inside of the cover strip, in close vicinity of a reed switch inside the instrument.
2. By removing the front section of the enclosure which contains the main processor board and batteries. Once removed, the PRESET key is pressed to enter the Program Mode.

The PRESET switch is used to step through the program (CAL sequence) and the \blacklozenge and $<$ keys on the front panel are used to change and increment the flashing digits. Six CAL steps are accessible in the Calibration mode. The CAL number is displayed on the lower display and the parameter is displayed on the upper display.

Any batch in progress when the Program mode is entered, is stopped and cannot be resumed. Also, no incoming pulses are totalised while the unit is in Program mode.

To exit the Program mode the lower cover strip should be returned to its original position or the front panel should be refitted.

Parameters in Program Mode that consist of the two parts, **whole numbers** and **digits after the decimal point**, are restricted to having a maximum of 6 significant digits. Therefore the number of significant digits entered in the *whole numbers* determines the number of digits that are able to be entered in the *digits after the decimal point*.

For Example

000001 in the whole numbers makes 0000 available after the decimal place.

000100 in the whole numbers makes 000 available after the decimal place.

010000 in the whole numbers makes 0 available after the decimal place.

10 Programming

4.1 PROGRAM STEPS

<i>Step</i>	<i>Comment</i>
CAL 01	Scaling Factor - whole numbers.
CAL 02	Scaling Factor - digits after the decimal point. The Scaling Factor is the pulses per unit of measure (eg. pulses/litre, pulses/gallon, etc). The Scaling Factor can be programmed in the range of 0.0001 - 999,999.
CAL 03	Decimal Point for Total Display. The total and preset quantity can be displayed with 0, 1, 2 or 3 decimal point places.
CAL 04	Start Time Delay. The time in seconds (0-9 sec) when Output 2 will switch "on" once the RUN key is pressed.
CAL 05	Prestop Quantity The quantity at which Output 2 will switch "off" before the end of the batch (Eg. If the Preset quantity is 100 litres and the Prestop quantity is 2 litres, Output 2 will switch off after 98 litres.)
CAL 06	Signal Timeout. A time period between 0-99 seconds during which, if there is no flow measured, the Outputs will both switch "off" and the PAUSE message will be displayed.
CAL 07	Batch Limit. This value determines the maximum preset value that may be entered by the operator. A value of zero for the batch limit disables this feature.
SOFT	Software Version.

4.2 EXAMPLE

A flowmeter produces 20.538 pulses per litre and has a maximum flowrate of 150 litres/minute. It is required to batch quantities in batches of around 300 litres and to alarm if there is no flow once the batch has started.

To increase the accuracy of the batch, a two stage valve will be used and the flow will be slow prior to the end of the batch to enable a more accurate cutoff.

It has also been decided to reduce the flowrate 10 litres prior to the end of the batch. The instrument is then programmed as follows:

<i>Step</i>	<i>Value of Parameter</i>	<i>Description</i>
CAL 01	00020	Scaling factor (Whole numbers).
CAL 02	5380	Scaling factor (Decimals).
CAL 03	1	One decimal place.
CAL 04	1	One second delay on full flow to stop pipe hammer.
CAL 05	10	10 litre prestop.
CAL 06	2	Two second signal timeout.
CAL 07	350	350 litre batch limit.
SOFT	1.XX	Software Version.

5. VALVE CONTROL AND DC POWER

The Model 114 will operate from an external power source between 9-28VDC and draws no more than 4mA. This enables the instrument to be powered from AC mains adaptors and eliminate the need to run mains voltage in the field.

As the instrument has an internal battery backup it will power the instrument if DC power is interrupted, but these batteries are not capable of powering the solenoids or sensors if they require external power (see section 6 for further description of operation with battery backup.)

Solid state relay outputs provide control to solenoids or relays and can sink up to 200mA. The outputs are internally protected against voltage spikes caused by relays and coils. Connections for a dual stage applications is given on the following page.

For single stage applications, only Output 1 is required.

Specification for Outputs

Maximum Current (sink):	200mA.
Maximum Voltage:	30VDC.
Saturation Voltage:	0.8VDC max across the outputs in the "on" state.

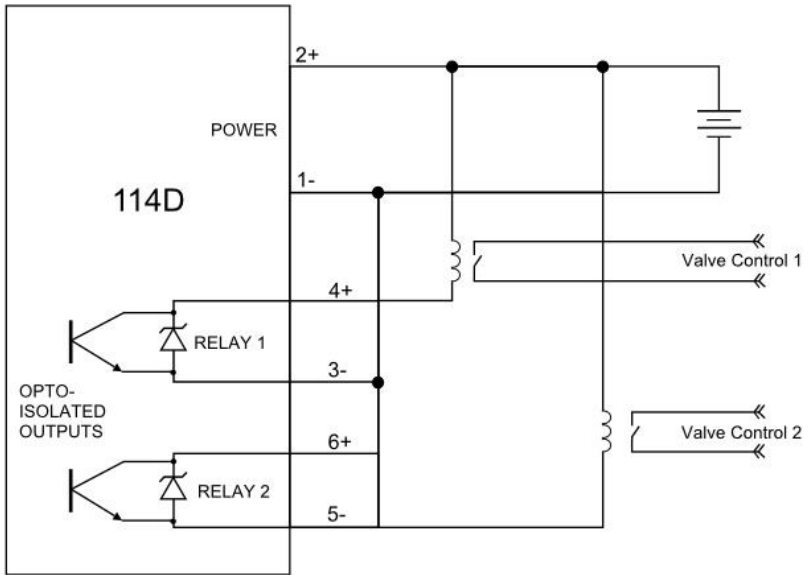

Relays with DC Coils

6. BATTERY BACKUP

The Model 114 has battery backup for the instrument if the supply has been interrupted. The lithium battery packs provide sufficient capacity to power the instruments for up to 2 years and the operator is warned of a low power condition by a message on the LCD display.

Note: No low battery warning will be displayed whilst there is external DC power connected.

6.1 POWER INTERRUPTION

With battery backup the Model 114 has the ability to resume a batch if the DC power is interrupted during a delivery. The 114 will also totalise any incoming pulses while power is unavailable.

If a batch is in progress and the external DC power is lost, both relay outputs will be deactivated and the batch will be paused. The paused batch can only be restarted when the DC power returns. However, the paused batch will be terminated if the STOP key is pressed or if any totalising of pulses causes the Batch Total to exceed the Preset Value.

7. FLOWMETER INPUT

The Model 114 has an input conditioning circuit which will accept signals from most **pulse** or **frequency** producing flowmeters. Links on the LCD panel enable the input circuit to be configured for different signal types.

The input will interface directly to:

- ◆ Turbine flowmeters.
- ◆ Open collector outputs.
- ◆ Reed switches.
- ◆ Logic signals.
- ◆ Two-wire proximity switches.

The following pages give examples of interconnection to various signal outputs. A circuit diagram of the input is also provided.

For pulse or logic type signals, the input switching threshold is 1.3 volts. That is, the input signal must have a "low" voltage of less than 1.2 volts and a "high" voltage of greater than 1.4 volts.

For flowmeters with coils, the minimum input voltage is 15mV P-P.

All inputs are protected for over voltage up to 28 volts.

16 Flowmeter Input

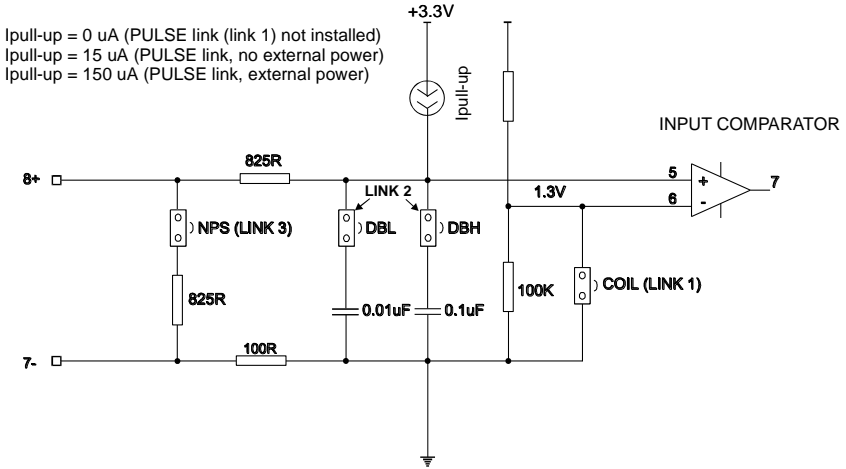

Simplified Frequency Input Circuit

Flowmeter Input 19

1. Squarewave, CMOS or Pulse

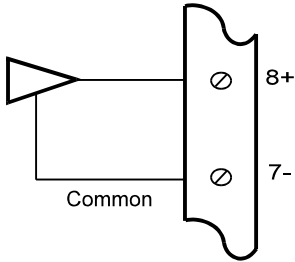

Link Settings

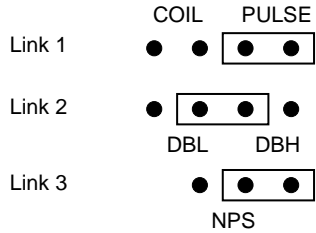

Switching threshold voltage is 1.3 volts.

2. Open Collector

With 150µA/150µA internal pull up current

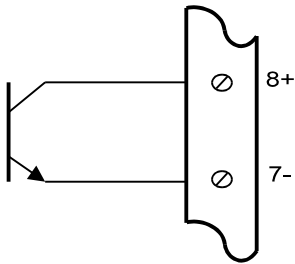

Link Settings

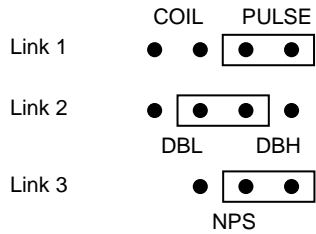

3. Reed Switch - External DC Power

With 150µA internal pull up current

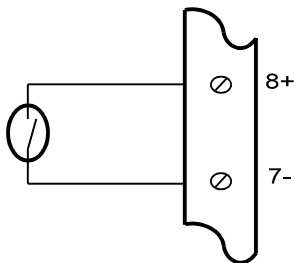

Link Settings

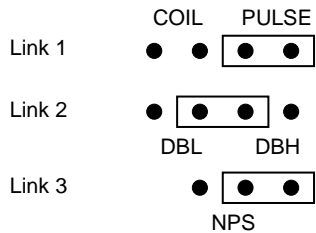

18 Flowmeter Input

Note: For a switch or reed input with contact bounce link DBH can be switched "on" by linking across the two right pins above DBH. This will eliminate the effect of switch bounce while limiting the input frequency to 200Hz.

4. Coils

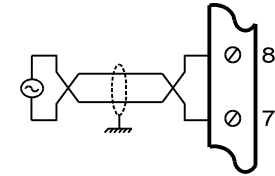

OR

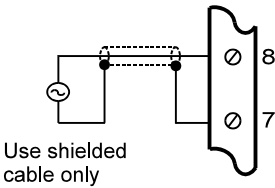

Link Settings

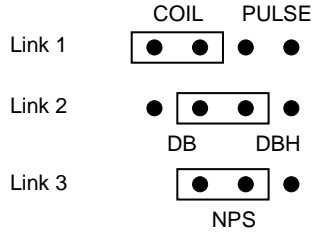

825R input impedance

eg. Millivolt signal from paddlewheel or turbine (15mV P-P minimum).

Note: If the input has a very high impedance, the following link settings should be used:

Link Settings

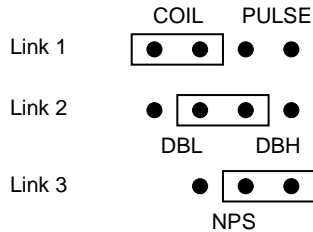

5. Namur Proximity Switch

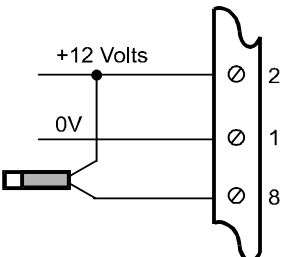

Link Settings

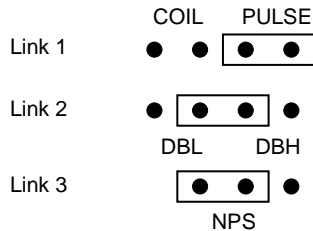

825R input impedance

For IS connections of Namur switches see Section 8.

6. Namur Proximity Switch - External DC Power

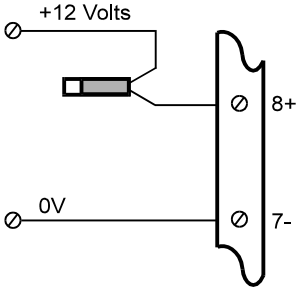

Link Settings

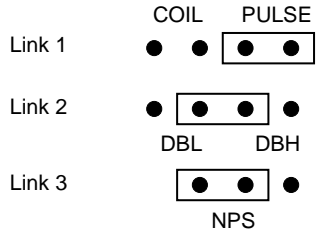

825R input impedance

8. INSTALLATION

8.1 WALL MOUNTING

A wall mounting bracket is supplied with each instrument. Round head screws should be used to attach the bracket to the wall (countersunk screws should not be used). The bracket is mounted first with the tray section at the bottom. The instrument is then mounted on the bracket with two screws as shown below.

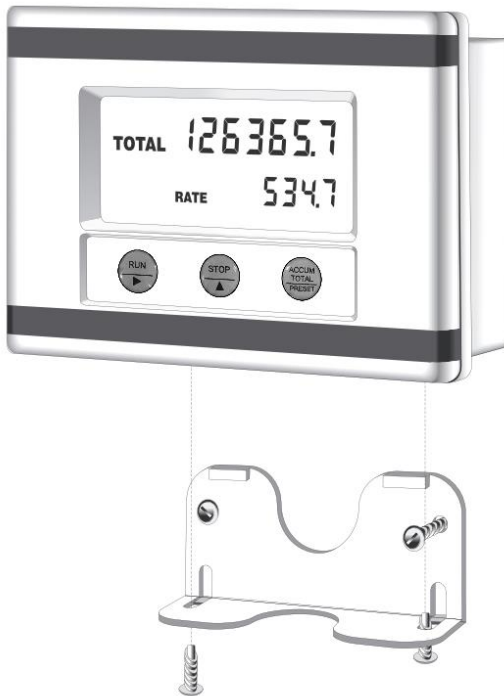

8.2 REMOVING THE FRONT PANEL

The front panel should be removed as follows:

1. Remove the top and bottom cover strips (ie. the dark plastic strip) by levering a screwdriver under one end.
2. Undo the screws retaining the front. Do not remove the screws, they are retained by O-rings.
3. Remove the front panel from the housing.

To replace the front cover, follow the above procedure in reverse. Ensure that the front panel is aligned at connector points before tightening the screws.

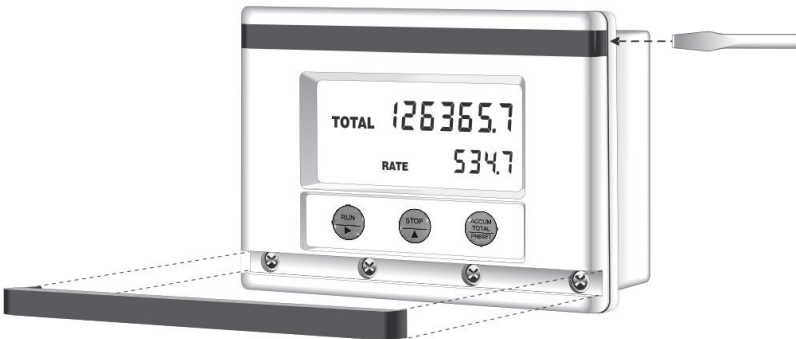

8.3 THE MAIN ELECTRONICS

The front section of the housing contains the microprocessor, display and the batteries if fitted. It is possible to adjust the display contrast via a small potentiometer on the board. The **Display Contrast** is shown below and this can be adjusted for optimum contrast.

Adjacent to this control is a **RESET** switch which can be used to reset the microprocessor. *Note that pressing this button will set the totals to zero and set the preset value to a default figure of 10.*

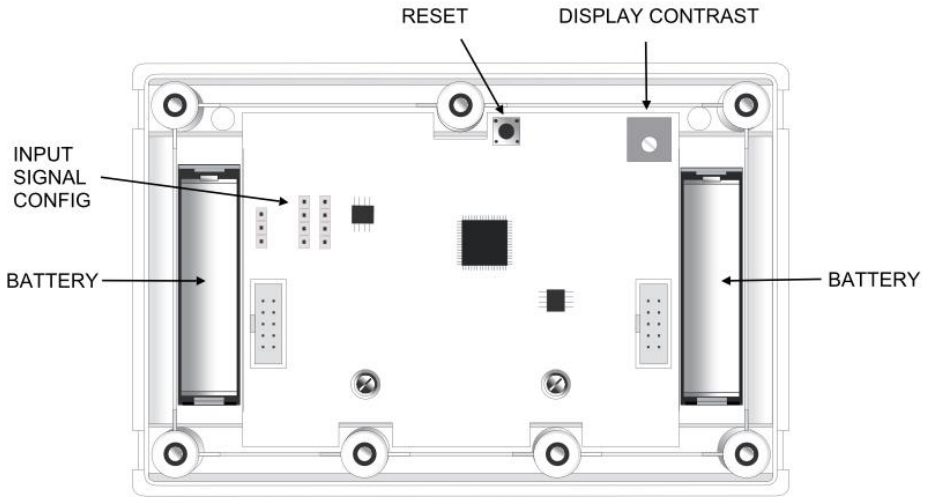

8.4 WIRING

When connecting the 114 it is good practice to use shielded cable. The shield should be connected to earth at one end of the cable. The other end of the shield should not be connected.

This wiring practice is mandatory in order to comply with the requirements for Electromagnetic Compatibility as per EMC-Directive 2014/30/EU of the Council of the European Community.

8.5 MAINTENANCE

All printed circuit boards must be repaired by Contrec Manufacturing Ltd.

8.6 TERMINAL DESIGNATIONS

All versions

8	Pulse (+) / Coil Input
7	Pulse (-) / Coil Input
6	Output 2 (+)
5	Output 2 (-)
4	Output 1 (+)
3	Output 1 (-)
2	DC Power +9 to 28V
1	DC Power 0V

Index

A

Accumulated Total, 1, 2, 4, 6

B

Batch Limit, 5, 10, 11
Batch Operations, 7
Batch Total, 2, 14
Battery Backup, 2, 12, 14

C

Cable Entry, 3
CAL Sequences, 9
Coils, 12, 15
Control Outputs, 17

D

DC Power Input, 2
Decimal Point, 9
Display Contrast, 22
Display Test, 6

E

Example, 11
External Power, 12

F

Flow Alarm, 8
Flowmeter Input, 15
Frequency Range, 2

G

I

Input Signal, 15
Installation, 20
Isolation, 2

K

K-factor, 2

L

Link Settings, 17
Low Battery, 14

M

Mounting, 20

N

Namur Proximity, 18,19

O

Open Collector, 15
Operation, 4

P

Pause Batch, 5, 8, 14
Prestop Quantity, 4
Programming, 9

R

Reed Switch, 17
Relay Output Test, 6
Relays, 12
Removing the Front Panel, 21

Reset Switch, 22

S

Scaling Factor, 10
Signal Timeout, 8
Solenoids, 12
Start Time Delay, 10
Starting, 5
Stopping, 5
Switching Power, 2
Switching Threshold, 15

T

Temperature, 3
Terminal Designations, 23
Test Mode, 6
Turbine Flowmeters, 15
Two-wire Proximity Switches, 15

W

Wiring, 23