

Intech 2400-IS

Isolated Auto-Detecting Converter

USB/RS232 to RS485/422/232



Installation Guide.

2400-IS Isolating Converter Installation Guide:

Description.	Page 3
Ordering Information.	Page 3
Features.	Page 3
Specifications.	Page 3
Physical Layout.	Page 4
2400-IS Connections.	Page 4
Outstation Layout.	Page 6
<i>2 Wire RS485 Connections.</i>	Page 6
<i>4 Wire RS422 Connections.</i>	Page 7
Connection to a MicroScan SCADA System.	Page 8
Connecting a RS485 Field Station to an Existing RS422 Data Hi-way.	Page 9
2300 Series Connections.	Page 10
Wiring and Installation.	Page 11
Replacing an existing 2100-IS with the 2400-IS (MicroScan).	Page 12

Product Liability. This information describes our products. It does not constitute guaranteed properties and is not intended to affirm the suitability of a product for a particular application. Due to ongoing research and development, designs, specifications, and documentation are subject to change without notification. Regrettably, omissions and exceptions cannot be completely ruled out. No liability will be accepted for errors, omissions or amendments to this specification. Technical data are always specified by their average values and are based on Standard Calibration Units at 25C, unless otherwise specified. Each product is subject to the 'Conditions of Sale'.

Warning: These products are not designed for use in, and should not be used for patient connected applications. In any critical installation an independent fail-safe back-up system must always be implemented.

2400-IS Isolating Converter USB/RS232 to RS485/422/232.

Converts and Isolates USB/RS232 from a computer to RS485/422/232 (Auto-Detecting) for communication to a field datalogging system.

Description:

The 2400-IS is a compact desktop module that isolates and converts USB or RS232 from a computer to RS485, RS422 or RS232 for communication to a field data logging system. It's driver and receiver meet EIA standards RS-422-A and CCITT recommendations V.11 and X.27 and is designed for multipoint transmission on long bus lines in noisy environments. The module can be powered from the computers USB port, or from an external 5Vdc power adapter (not supplied).



Ordering Information:

2400-IS Isolated Auto-Detecting USB/RS232 to RS485/RS422/RS232 Converter.

Complete with:

- USB cable (length = 1m).
- RS232 cable (length = 2m) - for PC connection.

Features:

- Isolation Between Computer and Field.
- Powered Via Computer USB Port, (or 5Vdc external power adapter, not included).
- Fully Compatible with USB 2.0.
- Supports RS485 Field Stations / Controllers on an Existing RS422 Data Hi-way.
- Supports Multiple Baud Rates.
- Stylish Compact Desktop Case.
- Easy to Install.

Specifications:

Power Supply	5Vdc.
Max Current	130mA.
Operating Temperature	-40° ~ +85°C.
Computer Input Types:	
USB	USB-B type (Fully compatible with USB 2.0 connections).
RS232	DB9-Female.
Field Outputs:	
RS485/422	6-pin screw terminal.
RS232	RJ-11.
Comms Baud Rates:	
USB	300~256000 Baud.
RS485/422/232	300~128000 Baud.
Dimensions	L=119mm, W=72mm, D=26mm.
Weight	0.1Kg.

Note: USB cable cannot exceed 5m.

RS232 cable cannot exceed 15m.

2400-IS Physical Layout:



LED indicators:

- PWR** Power status - Lights up when power is supplied to the *USB 5Vdc* input.
- USB** USB status - Lights up when a USB or power adapter is connected to the *USB 5Vdc* input, and there is no RS232 cable connected to the *RS232 DB9* Input. This indicates that the module will convert the USB interface from the computer to the RS485/422/232 interface of the field devices.
- RS232** RS232 status - Lights up when a RS232 cable is connected to the *RS232 DB9* input. This indicates that the module will convert the RS232 interface from the computer to the RS485/422 interface of the field devices. Please note that the *USB 5Vdc* input still requires a power supply either from a USB port on your computer or an external power adapter.
- Rx** Field receiving status - Lights up when the converter is receiving data from the field devices.
- Tx** Field transmitting status - Lights up when the converter is transmitting data to the field devices.

2400-IS Connections:



RS232 DB9 Input:

- Pin 1:** No Connection
- Pin 2:** Tx
- Pin 3:** Rx
- Pin 4:** No Connection
- Pin 5:** GND
- Pin 6:** No Connection
- Pin 7:** No Connection
- Pin 8:** No Connection
- Pin 9:** No Connection

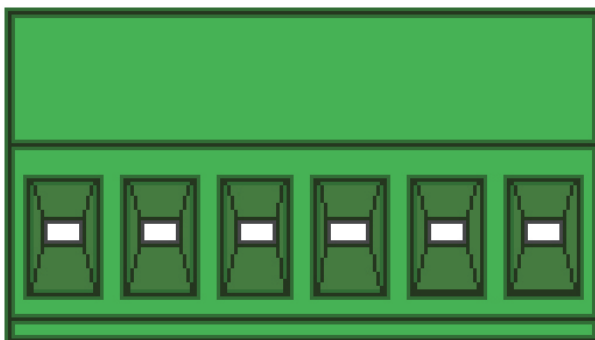

5-Pin Screw Terminal Output:

RS485:

- Pin 70:** Tx-/Rx-
- Pin 71:** Tx+/Rx+
- Pin 72:** No Connection
- Pin 73:** No Connection
- Pin 74:** COM
- Pin 75:** No Connection

RS422:

- Pin 70:** Tx-
- Pin 71:** Tx+
- Pin 72:** Rx-
- Pin 73:** Rx+
- Pin 74:** COM
- Pin 75:** No Connection

75	74	73	72	71	70
NC	COM	Rx+	Rx-	Tx+	Tx-

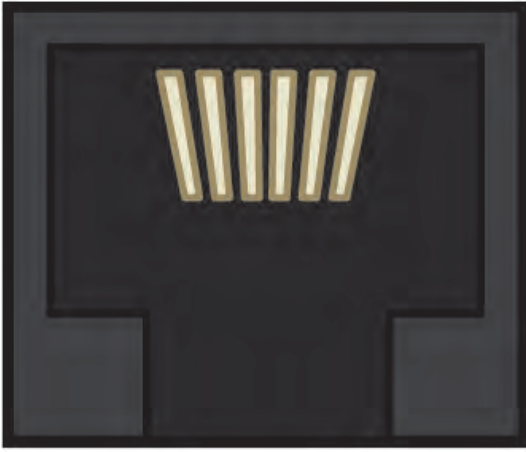

1 6

RS232 RJ11 Output:

- Pin 1:** No Connection
- Pin 2:** Tx
- Pin 3:** Rx
- Pin 4:** No Connection
- Pin 5:** GND
- Pin 6:** No Connection

Note: RS232 cable cannot exceed 15m.



USB connection:

The USB connection of the 2400-IS requires a driver before installation. If you already have MicroScan V5 installed on your PC (Build: 5.0.3050.17 or later), then the driver will already be installed. However if you need to install the driver manually, then you can download the file required from the following location:

www.intech.co.nz/2400isdriver

Typical Input Examples:

Data via RS232, Power via USB:



2400-IS Converter automatically defaults to RS232 COMMS when an RS232 cable is detected. USB must also be connected for power.

Data and Power via USB:



CAUTION: USB cable cannot exceed 5m.
 RS232 cable cannot exceed 15m.
 Do NOT cut USB/RS232 cable to extend the length.



Outstation Layout - RS485:

2 Wire RS485 Connections:



Never guess Tx or Rx connections.
Follow the terminal numbers in the serial connections diagrams exactly.

Important:

1. All cables must be screened.
2. All screens must be connected together.
3. The screen must not be earthed at any point.



2400-A16 / 2400-M-R Remote Station.



2100-A16 / 2100-A4 Remote Station.



2100-D Remote Station.



2100-AO Remote Station.

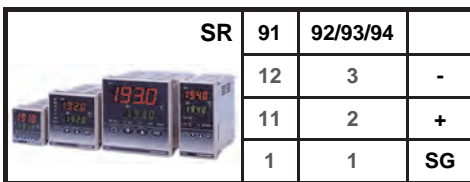

Shimaden SR90 Series with RS485 option.

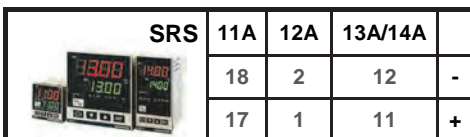

Shimaden SRS10A Series with RS485 option.

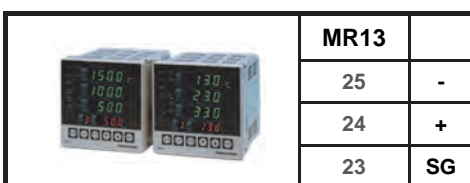

Shimaden MR13 with RS485 option.



Shimaden SD16A/24/20 with RS485 option.



Shimaden SR23 with RS485 option.

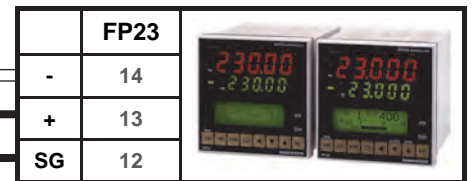

Shimaden FP23 with RS485 option.



Shimaden FP93 with RS485 option.

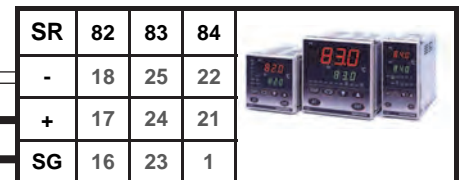

Shimaden SR80 Series with RS485 option.

**RS485 DATA HI-WAY.
CABLE POLARITY
MUST BE OBSERVED.**

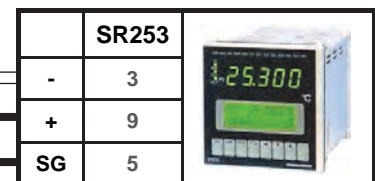

Shimaden SR253 with RS485 option.

TWISTED PAIR



End of Data Hi-way Junction Box;
Resistor = 1KΩ.

Outstation Layout - RS422:

4 Wire RS422 Connections:



Never guess Tx or Rx connections.
Follow the terminal numbers in the serial connections diagrams exactly.

Important:

1. All cables must be screened.
2. All screens must be connected together.
3. The screen must not be earthed at any point.

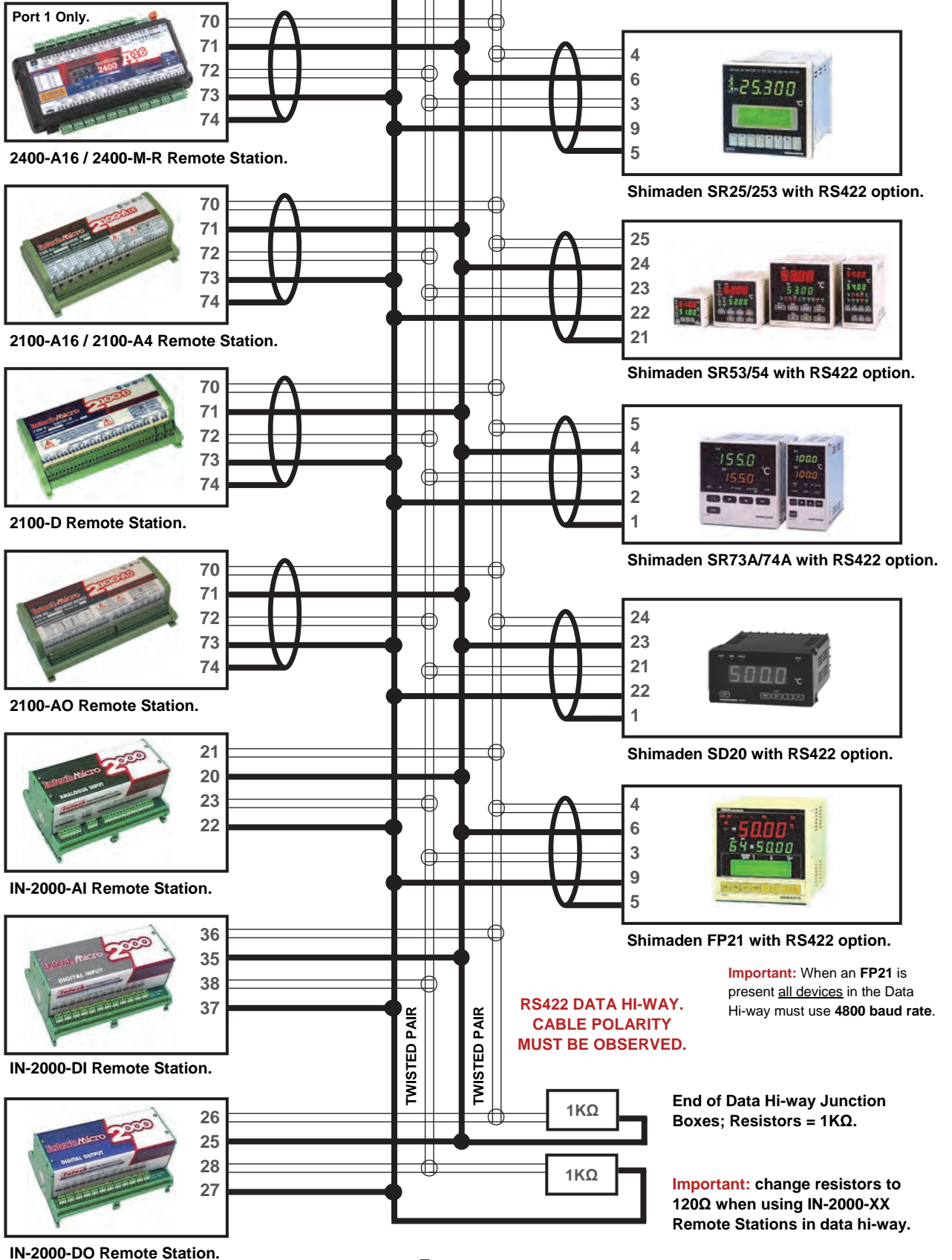

Connection to a MicroScan SCADA System:

RS485/422 Data Cabling Installation example 1:

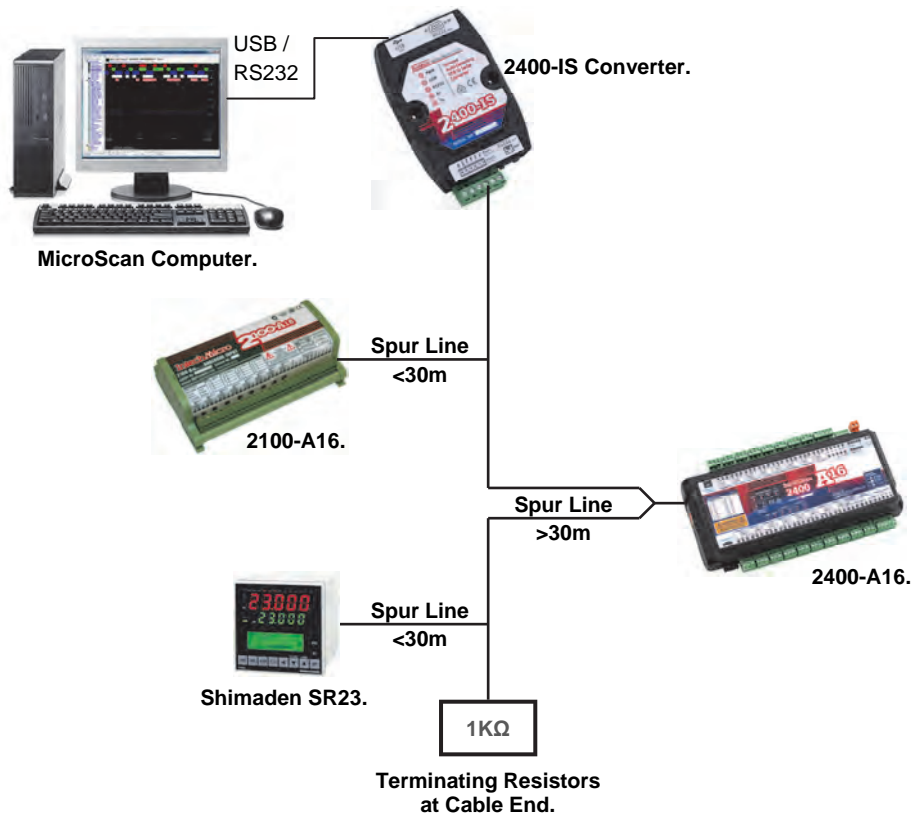

RS485/422 Data Cabling Installation example 2:

2400-IS converter may be placed anywhere along the data hi-way.

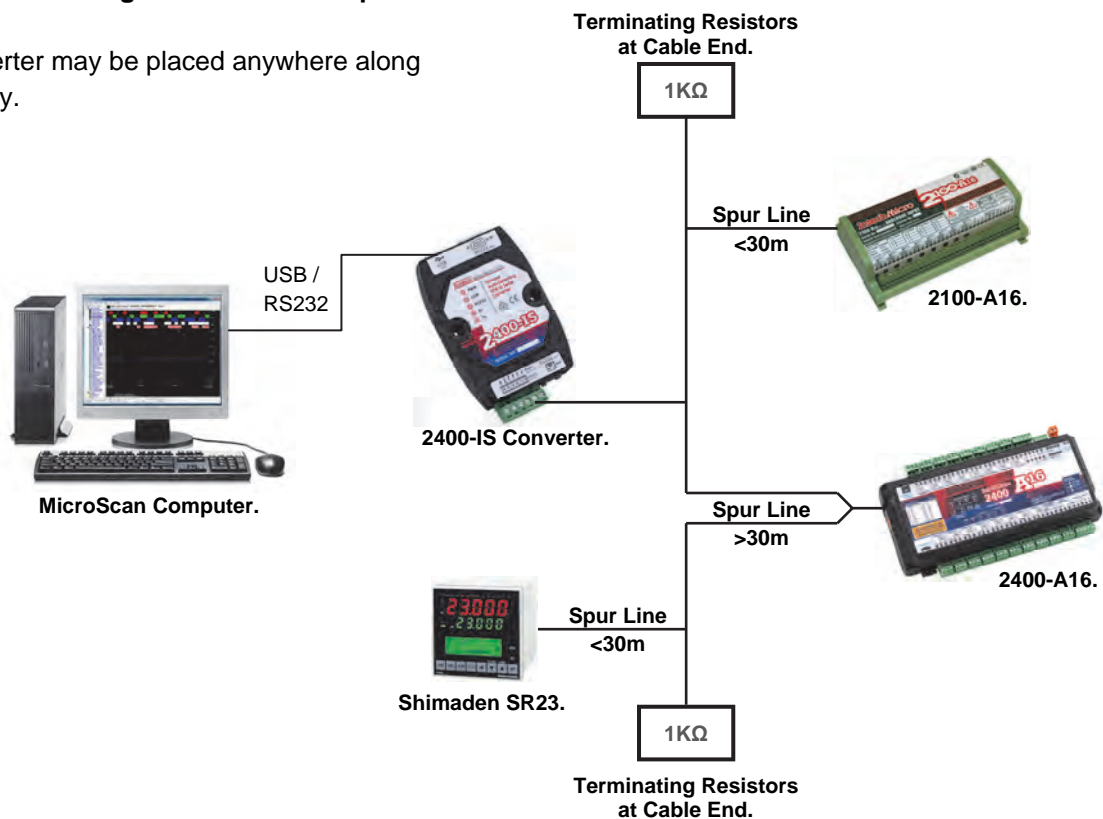

- Note:** Shimaden Controllers must have a unique serial number preprogrammed before connecting to the COMMS data hi-way. All signals and power must be de-energised before connecting to any wiring.
- Note:** Total length of trunk line, including spurs, is not to exceed, typically 500m using RS485 or typically 1200m using RS422.

IMPORTANT: The accompanying Installation Instructions must be strictly adhered to.

Connecting a RS485 Field Station / Controller to an Existing RS422 Data Hi-way:

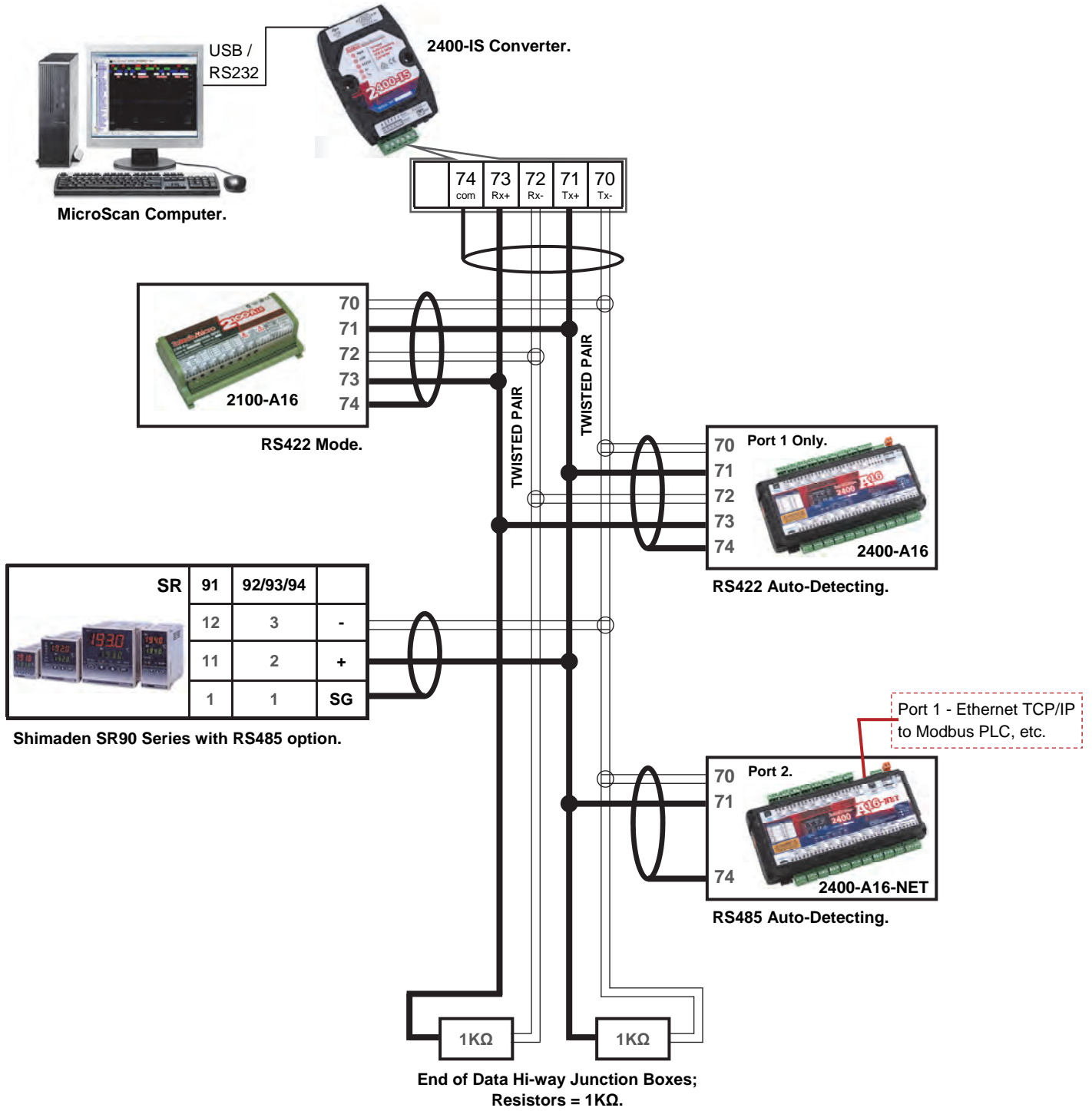

Note: This type of connection is only supported by the 2400-IS converter.

2300 Series Connections - RS485 only:

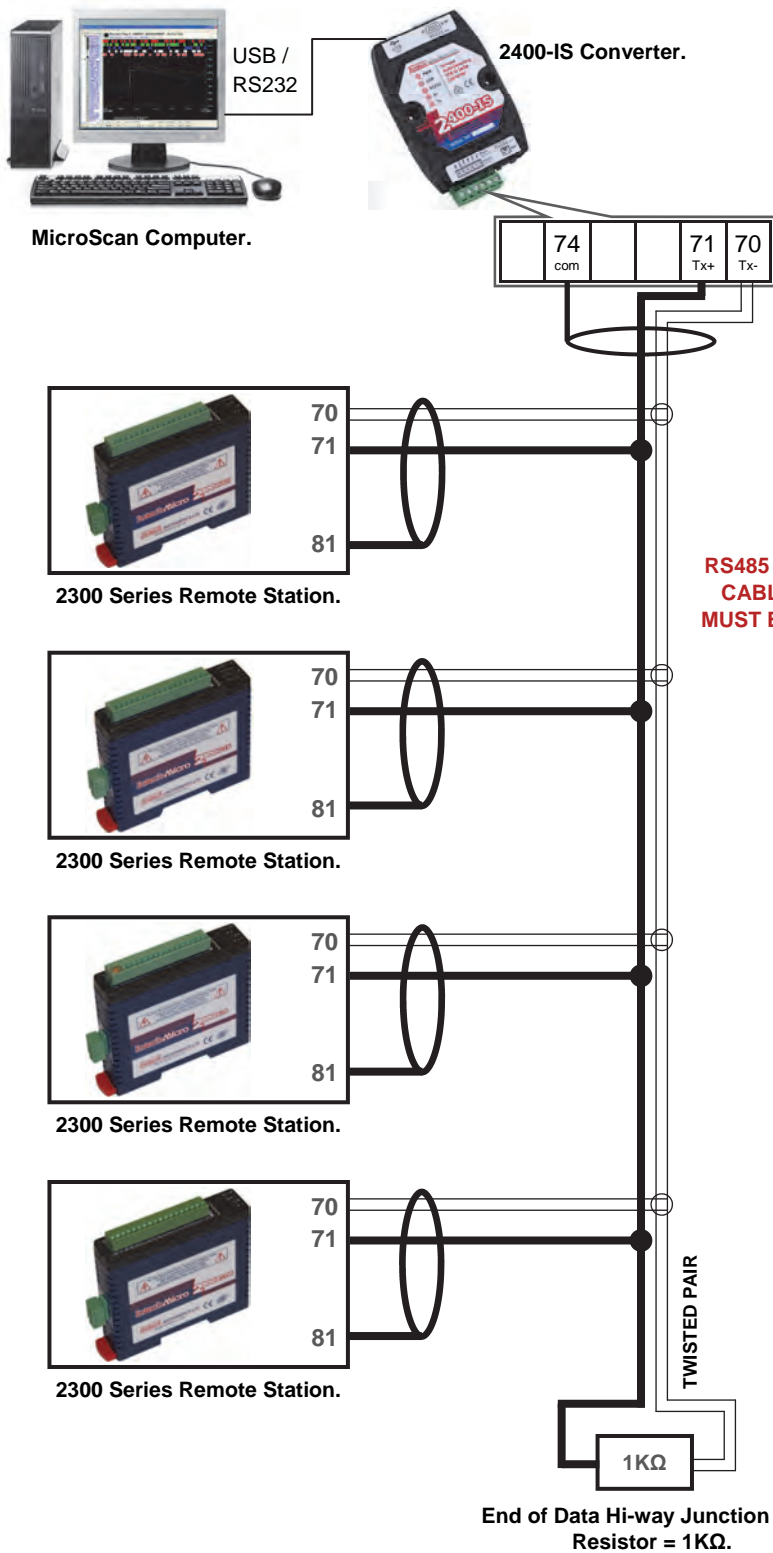

Never guess Tx or Rx connections. Follow the terminal numbers in the serial connections diagrams exactly.

Important:

1. All cables must be screened.
2. All screens must be connected together.
3. The screen must not be earthed at any point.
4. **WARNING!** Take care to ensure that the screen does NOT contact terminal 82 on the 2300 station - damage will result.

**RS485 DATA HI-WAY.
CABLE POLARITY
MUST BE OBSERVED.**

Important: The 2300-XX stations **cannot** share a data hi-way with the 2400-XX / 2100-XX stations and/or Shimaden Controllers.

Wiring and Installation:

The Prober Installation and Wiring of the 2400-IS:

All power and signals must be de-energised before connecting any wiring.

Mounting:

- 1) Mount in a clean environment.
- 2) Do not subject to vibration, excess temperature or humidity variations.
- 3) Avoid mounting near power control equipment.
- 4) Allow 10mm minimum clearance between the 2400-IS terminals and ANY conductive materials.

Cover Removal:

Removing the cover of the 2400-IS will void the warranty. The 2400-IS has no user serviceable parts.

USB driver:

The USB connection of the 2400-IS requires a driver before installation. If you already have MicroScan V5 installed on your PC (Build: 5.0.3050.17 or later), then the driver will already be installed. However if you need to install the driver manually, then you can download the file required from the following location: www.intech.co.nz/2400isdriver

RS485/422 Comms Signal Cabling:

- 1) Use only low capacitance, twisted pair, overall screened data cable. The cable must equal or better the following specifications:

Cable Specifications:		
Conductor Size.		7/0.20mm, 24AWG
Conductor Resistance @ 20°C.		8.9Ω/100m
Max. Working Voltage.		300Vrms
Capacitance Between Wires of a Pair.		50pF/m
Capacitance Between Each Wire to All Others Bunched Together.		95pF/m
Cross-Talk Between Pairs.	@ 1KHz	>-90dB/100m
	@ 100KHz	>-50dB/100m
Characteristic Impedance.	@ 100KHz	135Ω
Attenuation of a Pair.	@ 1KHz	.15dB/100m
	@ 10KHz	.42dB/100m
	@ 50KHz	.80dB/100m
	@ 100KHz	.90dB/100m
	@ 1MHz	1.9dB/100m
	@ 1.5MHz	2.4dB/100m

Note: All cables are to be subject during manufacture to in-process spark testing @ 4kVrms.

All cables are to be tested between conductors and conductors to screen for 1min @ 1500Vrms.

- 2) Minimum cable pairs: RS485 = 1 (*Plus overall screen*), RS422 = 2 (*Plus overall screen*).
- 3) Take care not to stress or damage cables during installation.
- 4) Total length of trunk line, including spurs, is not to exceed, typically 500m using RS485 or typically 1200m using RS422, without isolating boosters.
- 5) Terminating resistors - 1kΩ.
- 6) Cabling paths should avoid sources of radio frequency interferences such as fluorescent lights, variable speed motor drives, welding equipment, radio transmitters, etc.
- 7) There should be a minimum of 200mm physical separation between power cables and data cables.
- 8) Data cables should not be exposed to excessive heat or moisture, and should not be buried directly in the ground without protection.
- 9) Avoid powering a remote station or controller from the same power supply as a variable speed drive.
- 10) All unused twisted pairs should be terminated at both ends with 1kΩ resistors. DO NOT ground unused pairs.
- 11) **Important:** The 2300-XX stations **cannot** share a data hi-way with the 2400-XX / 2100-XX stations and/or Shimaden Controllers.

Commissioning:

- 1) Check that all the above conditions have been met, and that the wiring is checked, before connecting the USB cable from the computer to the 2400-IS.
- 2) Set the comm port in MicroScan to suit (Setup Tools > MicroScan Interface).
Check comms with Find Stations, Station status shows Station X Good (bottom left of MicroScan window).

Replacing an existing 2100-IS with the 2400-IS (MicroScan):

The **2400-IS** is designed for easy, drop-in, replacement of an existing **2100-IS** on the data hi-way.

Follow these steps:

- 1) Install the USB driver from: www.intech.co.nz/2400isdriver
- 2) Connect USB cable from computer to the USB input of the 2400-IS.
- 3) Take the 6-pin screw terminal plug from the 2100-IS and remove the power supply wiring from terminals 74/75, then connect to the 2400-IS (terminals 70~75).
- 4) Change the comm port in MicroScan to suit (Setup Tools > MicroScan Interface).
- 5) Check comms with Find Stations, Station status shows Station X Good (bottom left of MicroScan window).

Note:

The 2100-IS is discarded. Do not connect the existing gray moulded plugs from the 2100-IS to the 2400-IS.

The 2400-IS supports both RS422 and RS485. No linking is required.

When connected to USB only, the 2400-IS led's will be on:

PWR, USB, TX and RX will flash as communications happen.

