

## IN-RTB

### Flow Rate and Batching Controller.



## Installation Guide.

---

## ***IN-RTB Installation Guide Index.***

SECTION 1. – Description and Ordering Information.	Page 3
SECTION 2. – Specifications.	Page 3
SECTION 3. – Case Schematics.	Page 4
SECTION 4. – Input Jumper Configuration.	Page 4
4.1 – <i>Position your input jumpers.</i>	Page 5
SECTION 5. – Wiring.	Page 5
5.1 – <i>Connect your controller to the power supply.</i>	Page 5
5.2 – <i>Wire your IF11 analogue input module.</i>	Page 6
5.3 – <i>Wire your relays (if fitted).</i>	Page 7
5.4 – <i>Wire your analogue output (if fitted).</i>	Page 7
5.5 – <i>Wire your serial port (if fitted).</i>	Page 7
5.6 – <i>Wire your function pins (if required).</i>	Page 7
5.7 – <i>Power up your controller.</i>	Page 7
SECTION 6. – Setup & Calibration.	Page 7
6.1 – <i>Enter PIN.</i>	Page 7
6.2 – <i>Input setup.</i>	Page 7
6.3 – <i>Totaliser setup.</i>	Page 9
6.4 – <i>Batching setup.</i>	Page 9
6.5 – <i>Display setup.</i>	Page 9
6.6 – <i>User programmable input functions.</i>	Page 10
6.7 – <i>Analogue output setup.</i>	Page 10
6.8 – <i>Serial setup.</i>	Page 11
6.9 – <i>Edit calibration PIN.</i>	Page 12
SECTION 7 – Set-point Setup.	Page 12
7.1 – <i>Enter set-point PIN.</i>	Page 12
7.2 – <i>Edit set-points.</i>	Page 12
7.3 – <i>Edit set-point PIN.</i>	Page 15
SECTION 8 – Set-point Direct Access.	Page 15
8.1 – <i>Set-point direct access.</i>	Page 15
SECTION 9 – Display Shortcuts.	Page 15
9.1 – <i>View.</i>	Page 15
9.2 – <i>Reset.</i>	Page 15
SECTION 10 – Reset PIN Numbers.	Page 16
10.1 – <i>Reset PIN numbers.</i>	Page 16
SECTION 11 – Display Brightness.	Page 16
11.1 – <i>Adjust display brightness.</i>	Page 16
<b>Appendix A – Register functions.</b>	Page 16
A.i – <i>Batching.</i>	Page 16
A.ii – <i>Volumetric pulse.</i>	Page 16

# IN-RTB (was IN-RTB4)

**Flow Rate and Batching Controller with relay output options.**

## SECTION 1. – Description.

The IN-RTB controller is the ideal solution for a variety of flow rate and batching applications. This controller has been designed for ease of use, with intuitive, scrolling text prompts that guide you step-by-step through the setup process. The IN-RTB has two rows of 6-digit LED display and five front-panel buttons, for easy setup and simple operator interface. The dual display allows you to view total and flow rate simultaneously. Up to four relay outputs, an analogue output and/or an RS485 / RS232 serial port can also be added.



## Ordering Information.

ITEMS	CODE		DESCRIPTION
SERIES	IN-RTB-		Flow Rate and Batching Controller
RELAY OUTPUTS	N-		None
	R2-		2x 5A relay outputs
	R4-		4x 5A relay outputs
ANALOGUE OUTPUT	N-		None
	A-		1x 4~20mA / 0~10V Analogue Output
SERIAL PORT	N-		None
	WS232		1x serial port isolated RS232 (RJ11 terminal)
	WS485		1x serial port isolated RS485 (screw terminal)
POWER SUPPLY	HV		85~265Vac / 95~370Vdc
	LV		15~48Vac / 10~72Vdc

**Ordering Example:** **IN-RTB-R4-A-WS485-HV** Flow Rate and Batching Controller; 4x 5A relay outputs, 1x 4~20mA / 0~10V Analogue output, 1 x Serial Port RS485, 85~265Vac / 95~370Vdc.

## SECTION 2. – Specifications.

Input	0~24Vdc, 0~30Vac.
Sensor types	NPN, PNP, Mag (20mV to 30V), TTL, digital, closed contact or NAMUR.
Sensor calibration	Direct K factor entry or pulses per unit of measurement.
K factor ranges	3 ranges for K factors, from 0.1 to 99.9999, 999.999 or 9999.99.
Frequency	2Hz to 10KHz.
Power supply	HV: 85~265Vac / 95~370Vdc or LV: 15~48Vac / 10~72Vdc.
Excitation	24Vdc (50mA max).
Accuracy	0.005%.
Temp drift	Typically 2ppm/°C.
Security	Setup is PIN code protected.
Case	48 x 96 x 119.5mm (H x W x D) 45.5 x 92.5mm panel cutout.
<b>FLOW</b>	
Flow rate	Units/sec, units/min or units/hour.
Rate multiplier	x0.0001 to x1000.
<b>TOTALISER</b>	
Resolution	x1, x103, x106.
Features	Low flow cutoff and reset at power up.
<b>FEATURES</b>	
Reset	Reset total and / or batch manually or via set-point logic.
Volumetric pulse	Adjustable pulse width from 0.1 to 10.0 seconds (see Appendix A.ii).
Batching	Batching mode available, with in-flight correction (see 7.2S).
<b>OPTIONAL</b>	
Relay outputs	2 or 4 x 5A Form A relays (1 used for batch set-point).
Analogue output	Isolated 16-bit 4~20mA / 0~10V output (fully scalable). Window programmable over the full-scale range.
Serial port	Isolated RS485 / RS232. <u>Modes:</u> ASCII, Modbus RTU slave, Ranger A. <u>Data rates:</u> 300~38400 baud. <u>Parity:</u> Odd, even or none.

## JUMPER SELECTABLE OPTIONS

Input noise filter jumper	20kHz, 2kHz, 200Hz, Filter OFF.
Input signal jumper	Logic (DC), Magnetic pickup (AC).
Load jumper	Sink/Source (digital transistor or switch interface), Namur (2-wire proximity detector), Tacho (AC magnetic pickup).

**Product Liability.** This information describes our products. It does not constitute guaranteed properties and is not intended to affirm the suitability of a product for a particular application. Due to ongoing research and development, designs, specifications, and documentation are subject to change without notification. Regrettably, omissions and exceptions cannot be completely ruled out. No liability will be accepted for errors, omissions or amendments to this specification. Technical data are always specified by their average values and are based on Standard Calibration Units at 25C, unless otherwise specified. Each product is subject to the 'Conditions of Sale'.

**Warning:** These products are not designed for use in, and should not be used for patient connected applications. In any critical installation an independent fail-safe back-up system must always be implemented.

## SECTION 3. – Case Schematics.

The IN-RTB has a 2 x 6-digit, 14-segment alphanumeric LED display, five front-panel buttons and five set-point annunciator LED's (BCH SP (SP1), SP2-5).

**Fig 1 - Front view:**

### BUTTON PRESS FUNCTIONS:

**A - Function 1:** This button is used to access the **input setup and calibration** menu. See Section 6.



**B - Program:** This button is typically used to save your settings and advance to the next step in the setup process. It can also be configured to operate as a short-cut key from the main display, performing one user-selected function from a list of options. See Section 6.6B.



**C - Up:** This button is typically used to scroll through options or increase values in the setup menu. Pressing the button from the main display will show the current values for **RATE**, **BATCH** and **PEAK**. See Section 9.



**D - Down:** This button is typically used to scroll through options or decrease values in the setup menu. Pressing this button from the main display will show the current values for **BT CNT** (batch count), **INFLIT** (inflight adjustment), **VALLEY** and **TOTAL**. See Section 9.



**E - Function 2:** This button is used to access the **set-point setup** menu (see Section 7) and the **set-point direct access** menu (see Section 8).

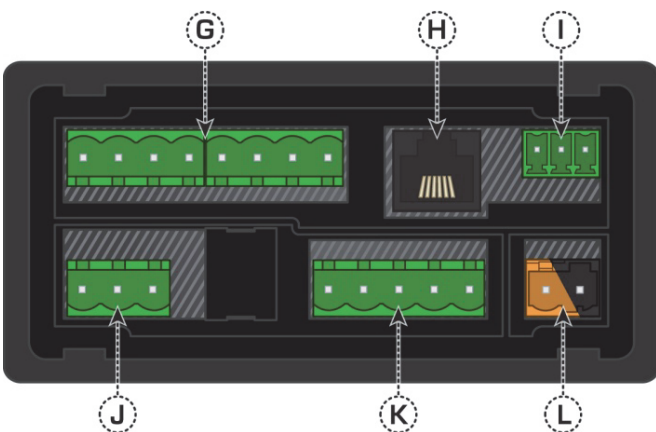
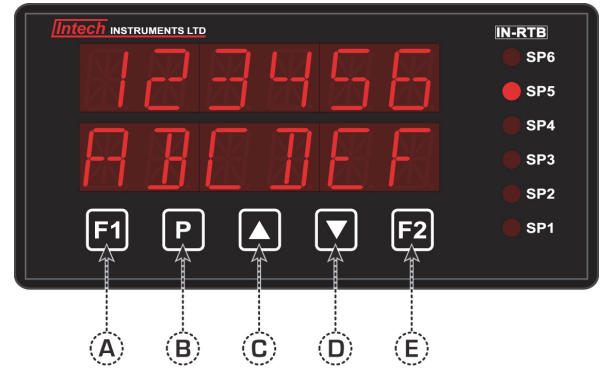

**Fig 2 - Rear view:**

### CONNECTOR PINS:

<b>G - Relays</b>	Wiring: Section 5.3
<b>H - Serial port</b>	Wiring: Section 5.5
<b>I - Analogue output</b>	Wiring: Section 5.4
<b>J - IF11 input module</b>	Jumper setup: Section 4. Wiring: Section 5.2
<b>K - Function pins</b>	Wiring: Section 5.6
<b>L - Power supply (HV/LV)</b>	Wiring: Section 5.1

## SECTION 4. – Input Jumper Configuration.

### Before you begin:

Before you can begin wiring, the IF11 input module must be removed from the meter case so that the Jumpers can be positioned for your input type. Remove the plastic backing plate from the rear of the meter by inserting a screwdriver into the indents circled on the image as shown:

Once the backing plate has been removed, gently slide the input module from the case (see Section 3.2D to identify the input module).



#### 4.1 – Position your input Jumpers:

The IF11 input module has four Jumpers, some of which may need to be repositioned to suit your application. Please consult the table below for more information on positioning the Jumpers to suit your requirements.

**Jumper B should always be set to COUNTER.** When you have finished, slide the input module back into the case and replace the plastic backing plate.

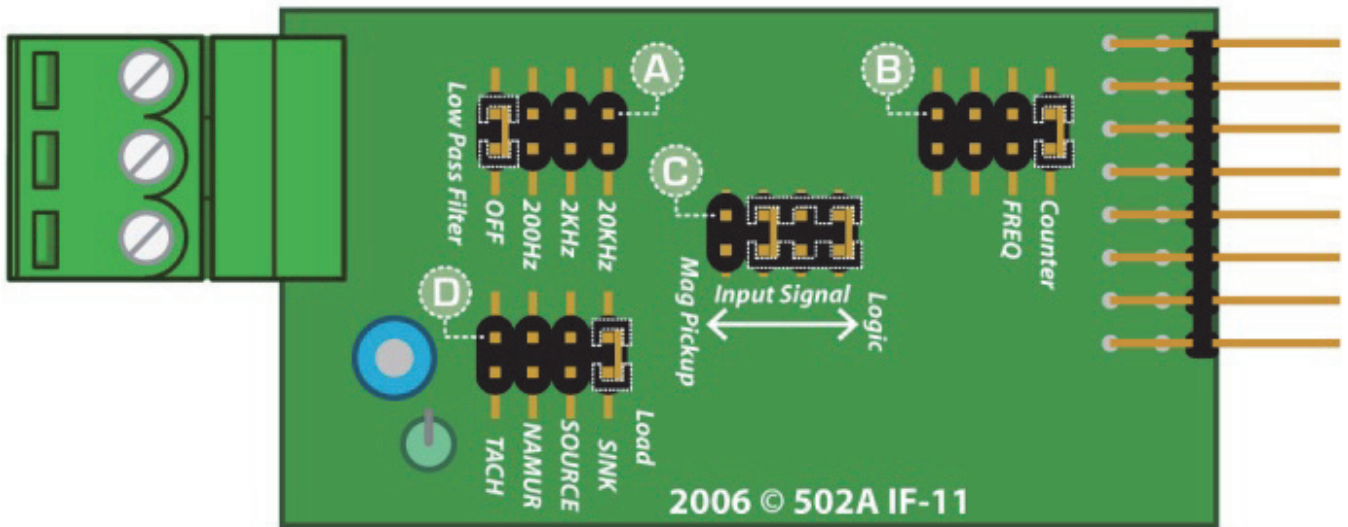

#### JUMPER POSITIONING:

- A - Input noise filtering** OFF: Ideal for high-speed counting  
2kHz: Suitable for a noisy signal  
20kHz: Ideal for mechanical contacts
- B - Mode** Counter: ALWAYS use this setting  
Frequency: Not used for IN-RTB
- C - Input signal** Logic: NPN, PNP, namur, TTL & pushbuttons  
Mag Pickup: Tacho
- D - Load** Sink: NPN, TTL & pushbuttons  
Source: PNP  
Namur: Namur  
Tach: Tacho

#### Example showing a Jumper In & Jumper Out:

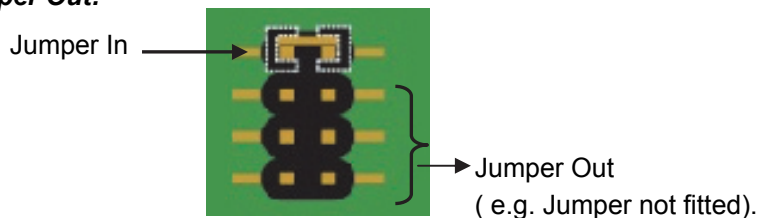

### SECTION 5. – Wiring.

#### Before you Begin:

Determine whether your controller is configured for low or high voltage power supply. Make sure to check the label on the unit against the colour of the power connector:

**Orange** = High voltage HV (85~265Vac / 95~370Vdc).

**Black** = Low voltage LV (15~48Vac / 10~72Vdc).

<p><b>5.1 – Connect your controller to the power supply:</b> Refer to 3.2L</p> <p>Wire your controller to your power supply as per the appropriate diagram.</p> <div style="border: 1px solid black; padding: 5px; text-align: center;"> <p><b>Remember to switch your power supply off before you begin wiring, and NEVER connect your low voltage controller to mains power.</b></p> </div>	<p><b>High voltage (HV) -</b> 85~265Vac / 95~370Vdc</p>	<p><b>Low voltage (LV) -</b> 15~48Vac / 10~72Vdc</p>
---	---	--

## 5.2 – Wire your IF11 analogue input module (when fitted):

Refer to 3.2J

Make sure that you have completed Section 4 before you begin wiring your input module. Once you have adjusted your Jumper settings as needed (see Section 4) and replaced the plastic backing plate, wire your input module as shown in the appropriate diagram:

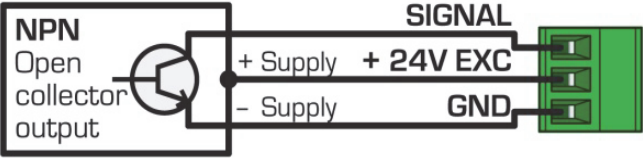
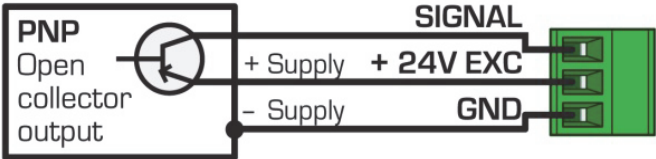
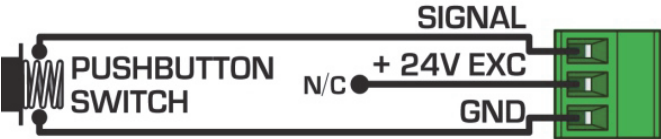
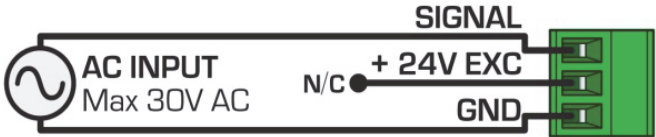
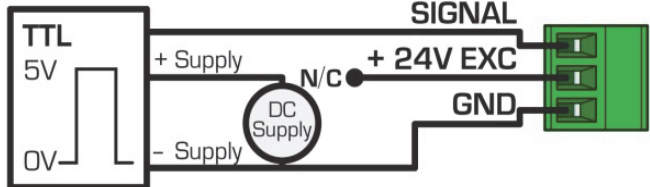
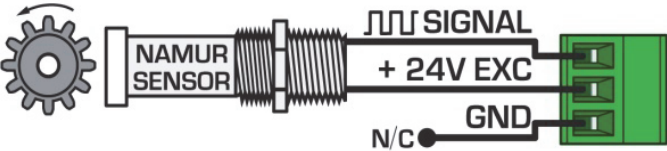
<p><b>NPN open collector output with proximity switch:</b> Active sensor signal: 0V. Inactive sensor signal: +24V.</p> 	<p><b>Jumper</b></p> <p><b>A</b> Input noise filtering: See table in section 4.1  <b>B</b> Mode: Counter  <b>C</b> Input Signal: Logic  <b>D</b> Load: Sink</p>
<p><b>PNP open collector output with proximity switch:</b> Active sensor signal: +24V. Inactive sensor signal: 0V.</p> 	<p><b>Jumper</b></p> <p><b>A</b> Input noise filtering: See table in section 4.1  <b>B</b> Mode: Counter  <b>C</b> Input Signal: Logic  <b>D</b> Load: Source</p>
<p><b>Pushbutton switch:</b> Open signal: +24V. Closed signal: 0V.</p> 	<p><b>Jumper</b></p> <p><b>A</b> Input noise filtering: See table in section 4.1  <b>B</b> Mode: Counter  <b>C</b> Input Signal: Logic  <b>D</b> Load: Sink</p>
<p><b>Tacho generator sensor:</b></p> 	<p><b>Jumper</b></p> <p><b>A</b> Input noise filtering: See table in section 4.1  <b>B</b> Mode: Counter  <b>C</b> Input Signal: Mag Pickup  <b>D</b> Load: Tach</p>
<p><b>TTL input:</b> In this example the TTL logic has a separate +5V power supply.</p> 	<p><b>Jumper</b></p> <p><b>A</b> Input noise filtering: See table in section 4.1  <b>B</b> Mode: Counter  <b>C</b> Input Signal: Logic  <b>D</b> Load: Sink</p>
<p><b>Namur sensor:</b> Active sensor signal: 0.3~1.0mA. Inactive sensor signal: 1.7~3.0mA.</p> 	<p><b>Jumper</b></p> <p><b>A</b> Input noise filtering: See table in section 4.1  <b>B</b> Mode: Counter  <b>C</b> Input Signal: Logic  <b>D</b> Load: Source</p>

### 5.3 – Wire your relays (if fitted):

Refer to 3.2G

Wire your relays as per the diagram. IN-RTB relays can be programmed to operate within the total span range of the controller. If you do not have any relays fitted, step 5.3 is skipped.

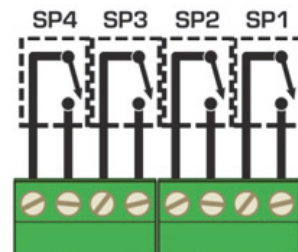

### 5.4 – Wire your analogue output (if fitted):

Refer to 3.2I

If your IN-RTB has an analogue output fitted, wire it as shown. If you do not have an analogue output, step 5.4 is skipped.

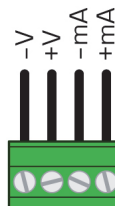

### 5.5 – Wire your serial port (if fitted):

Refer to 3.2H

If your IN-RTB has a serial port fitted, wire it as per the diagram. If you do not have a serial port fitted then step 5.5 is skipped.

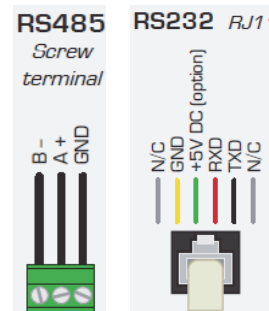

### 5.6 – Wire your function pins (if required):

Refer to 3.2K

Connect external switches as shown to enable a function to be executed when its switch is activated.

**User 1-3** Activating one of these pins will execute its user-defined function. (As specified in 6.6C-E).

**Test** Reset the meter

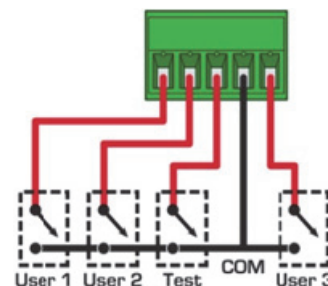

### 5.7 – Power up your controller:

Once you have completed the wiring process it is safe to switch on your power supply. Ensure that your display is functioning before you proceed.

## SECTION 6. – Setup & Calibration.

Enter the setup and calibration mode by pressing **[F1]**.

### 6.1 – Enter PIN:

**A** **\_\_\_ ENTER CAL PIN NUMBER** scrolls across the bottom row and **0** appears in the top row.

Use the **[▲]** and **[▼]** buttons to enter your security code (factory default = 1). Then press **[P]**.

If the correct PIN is entered then the setup is started at 6.2.

If an incorrect PIN number is entered, **\_\_\_ INCORRECT PIN NUMBER - ACCESS DENIED** scrolls across the bottom row and the controller returns to the normal operating mode.

**You will be given the opportunity to change your PIN number at the end of this section (6.9).  
If you have forgotten your PIN number, see Section 10.**

**Note:**

To SKIP or ENTER values - Push **[P]**

To SELECT a menu input - Push **[▲]**

### 6.2 – Input setup:

**A** **\_\_\_ FLOW RATE SETUP** scrolls across the bottom row and **SKIP** appears in the top row.

Press **[P]** to skip to 6.3, or the **[▲]** button and then **[P]** to **ENTER** flow rate setup.

**B** **\_\_\_ DECIMAL POINT POSITION** scrolls across the bottom row and the current selection appears in the top row.

Use the **[▲]** and **[▼]** buttons to select: **NO DP**, **0.1**, **0.12**, **0.123**, **0.1234** or **0.12345**. Then press **[P]**.

**C** \_\_\_ **CALIBRATION METHOD** scrolls across the bottom row and the current selection appears in the top row. Use the **▲** and **▼** buttons to select **K FCTR** (K Factor) or **PULSES**, and then press **P**.

**K FCTR** - Select this option for fast, accurate calibration using the sensor manufacturer's K factor value.

**PULSES** - This option is ideal for applications where the flow sensor's K factor value is not known. It is also a more accurate calibration method in rare situations where the known K factor is less than 1.

**If you selected K FCTR in 6.2C:**

**D** \_\_\_ **K FACTOR RANGE** scrolls across the bottom row and the current selection appears in the top row. Use the **▲** and **▼** buttons to choose: **99.9999**, **999.999** or **9999.99**, and then press **P**.  
 \_\_\_ **K FACTOR** scrolls across the bottom row and the current value appears in the top row. Use the **▲** and **▼** buttons to enter the K factor from your flow transducer manufacturer's specifications. Then press **P**.

**If you selected PULSES in 6.2C:**

**D** \_\_\_ **PULSES PER UNIT OF MEASUREMENT** scrolls across the bottom row and the current number of pulses appears in the top row. Adjust this value as using the **▲** and **▼** buttons, and then press **P**.  
*For example, if a flow sensor outputs 50 pulses/litre, set the PULSES PER UNIT OF MEASUREMENT to 50.*  
 \_\_\_ **ENTER DISPLAY VALUE FOR (X) PULSES** scrolls across the bottom row and the current display value appears in the top row. Adjust this value using the **▲** and **▼** buttons, and then press **P**.  
*If you selected 50 pulses above, and 50 pulses = 1 litre, then enter 1 here. (The controller will automatically calculate the correct scale factor for you.)*

**E** \_\_\_ **TIME PERIOD FOR RATE DISPLAY** scrolls across the bottom row and the current selection appears in the top row. Use the **▲** and **▼** buttons to select: **SECS**, **MINS** or **HOURS**, and then press **P**.  
*This parameter allows you to view the effective rate over different time periods. For example, if the measurement units are litres, then rate can be viewed in L/sec, L/min or L/hr.*

**F** \_\_\_ **RATE MULTIPLIER** scrolls across the bottom row and the current multiplication factor appears in the top row. Use the **▲** and **▼** buttons to select: **x0.0001**, **x0.001**, **x0.01**, **x0.1**, **x1**, **x10**, **x100** or **x1000**. Then press **P**.  
*This option allows the user add a scale factor to the rate display calculation, to display the value in the required units.*

**G** \_\_\_ **ROUNDING** scrolls across the bottom row and the current rounding appears in the top row. Use the **▲** and **▼** buttons to select: **NONE**, **2**, **5** or **10**, and then press **P**.

**H** \_\_\_ **DISPLAY ZERO TIME** scrolls across the bottom row and the current display zero time appears in the top row. Use the **▲** and **▼** buttons to select either: **0.5SEC** or **100SEC**, and then press **P**.  
*Controls how quickly the rate display changes to zero. Select 100SEC for slow inputs, and 0.5SEC for inputs with >2 pulses/sec.*

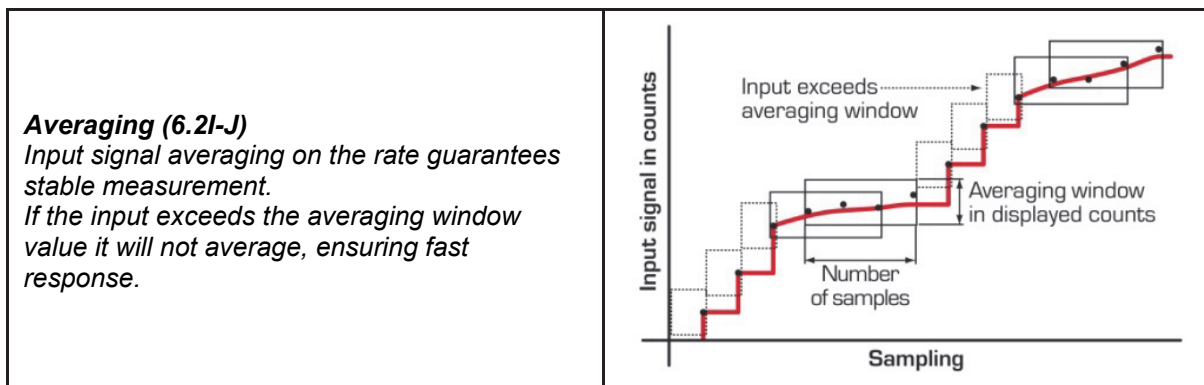

**I** \_\_\_ **AVE SAMPLES** scrolls across the bottom row and the currently selected averaging appears in the top row. Using the **▲** and **▼** buttons, alter the number of rate samples that the controller will average. Then press **P**.  
 Increasing the number of samples will stabilize measurement, but it will also slow down response rates.

**J** \_\_\_ **AVE WINDOW** scrolls across the bottom row and the currently selected averaging window value appears in the top row. Use the **▲** and **▼** buttons to alter the rate signal averaging window and then press **P**.

*If your input signal contains large noise spikes, then you can increase the size the of averaging window to ensure that these pulses are still averaged. However, increasing the averaging window too far will reduce the ability of the controller to respond quickly to real changes in input signal.*

*Setting the averaging window to zero will turn off the window mode and give continuous averaging as per the selected averaging samples.*



### 6.3 – Totaliser setup:

The totaliser can be reset from the rear function pins (see 6.6).

- A **\_\_\_ TOTALISER SETUP** scrolls across the bottom row and **SKIP** appears in the top row. Press **[P]** to skip to 6.4, or the **[▲]** button and then **[P]** to **ENTER** totaliser setup.
- B **\_\_\_ DECIMAL POINT POSITION** scrolls across the bottom row and the currently selected decimal point position appears in the top row. Use the **[▲]** and **[▼]** buttons to select: **NO DP**, **0.1**, **0.12**, **0.123**, **0.1234** or **0.12345**. Then press **[P]**.
- C **\_\_\_ RESOLUTION** scrolls across the bottom row and the currently selected totaliser resolution appears in the top row. Use the **[▲]** and **[▼]** buttons to select: **x1**, **10<sup>3</sup>** or **10<sup>6</sup>**. Then press **[P]**.
- D **\_\_\_ RESET AT POWER UP** scrolls across the bottom row and the currently selected setting appears in the top row. Use the **[▲]** and **[▼]** buttons to select either **NO**, **ZERO** or **LD VAL** (load value). Then press **[P]**.  
**NO** - The totaliser value will be retained at power up.  
**ZERO** - The totaliser value will be cleared to zero at power up.  
**LD VAL** (load value) - The totaliser value will be set to a user defined totaliser load value at power up (see 6.3E).
- E **\_\_\_ LOAD VALUE** scrolls across the bottom row and the currently selected totaliser load value appears in the top row. Use the **[▲]** and **[▼]** buttons to adjust your load value as desired. Then press **[P]**.  
This value is loaded into the totaliser at power up when **LD VAL** is selected in 6.3D above. It is also used with a number of user-definable input functions (see 6.6).

### 6.4 – Batching setup:

See Appendix A.i for more information on batching functions.

- A **\_\_\_ BATCHING SETUP** scrolls across the bottom row and **SKIP** appears in the top row. Press **[P]** to skip to 6.5, or the **[▲]** button and then **[P]** to **ENTER**.
- B **\_\_\_ RESET AT POWER UP** scrolls across the bottom row and the currently selected setting appears in the top row. Use the **[▲]** and **[▼]** buttons to select either **NO**, **ZERO** or **LD VAL** (load value). Then press **[P]**.  
**NO** - The batch value will be retained at power up.  
**ZERO** - The batch value will be cleared to zero at power up.  
**LD VAL** (load value) - The batch value will be set to a user defined batching load value at power up (see 6.4C).
- C **\_\_\_ LOAD VALUE** scrolls across the bottom row and the current batching load value appears in the top row. Adjust using the **[▲]** and **[▼]** buttons, and then press **[P]**.  
This value is loaded into the batch value at power up when **LD VAL** is selected in 6.4B above. It is also used with a number of user-definable input functions (see 6.6).

### 6.5 – Display setup:

- A **\_\_\_ DISPLAY SETUP** scrolls across the bottom row and **SKIP** appears in the top row. Press **[P]** to skip to 6.6, or the **[▲]** button and then **[P]** to **ENTER** display setup.
- B **\_\_\_ LINE 1 DISPLAY SOURCE** scrolls across the bottom row and the currently selected line 1 (top row) display source appears in the top row. Use the **[▲]** and **[▼]** buttons to select: **NONE**, **RATE**, **TOTAL**, **BATCH**, **BCH SP** or **BCHCNT**. Then press **[P]**.  
See Appendix A.i for more information on batching functions.
- C **\_\_\_ LINE 2 DISPLAY SOURCE** scrolls across the bottom row and the currently selected line 2 (bottom row) display source appears in the top row. Use the **[▲]** and **[▼]** buttons to select: **NONE**, **RATE**, **TOTAL**, **BATCH**, **BCH SP** or **BCHCNT**. Then press **[P]**.  
See Appendix A.i for more information on batching functions.

### 6.6 – User programmable input functions:

Refer to the table on the next page for a list of function descriptions.  
See Appendix A.i for more information on batching functions.

- A **\_\_\_ USER PROGRAMMABLE INPUT FUNCTIONS** scrolls across the bottom row and **SKIP** appears in the top row. Press **[P]** to skip to 6.7, or the **[▲]** button and then **[P]** to **ENTER** input functions setup.
- B **\_\_\_ PROGRAM BUTTON** scrolls across the bottom row and the currently selected **[P]** button function appears in the top row. Use the **[▲]** and **[▼]** buttons to select a function from the list. Then press **[P]** to confirm.  
This specifies the operation to be executed when the **[P]** button is pressed from the main display.
- C **\_\_\_ USER INPUT 1** scrolls across the bottom row and the currently selected User 1 pin function appears in the top row. Use the **[▲]** and **[▼]** buttons to select a function from the list, and then press **[P]** to confirm.  
This specifies the operation to be executed when the User 1 input pin at the rear of the meter is connected to the common pin (Section 5.6).

- D** **\_\_\_ USER INPUT 2** scrolls across the bottom row and the currently selected User 2 pin function appears in the top row. Use the **▲** and **▼** buttons to select a function from the list, and then press **P** to confirm.  
*This specifies the operation to be executed when the User 2 input pin at the rear of the meter is connected to the common pin (Section 5.6). Note that User Input 2 has unique options not available on other inputs, including HOLD (Hold all counts) and HOLD B (Hold batch count).*
- E** **\_\_\_ USER INPUT 3** scrolls across the bottom row and the currently selected User 3 pin function appears in the top row. Use the **▲** and **▼** buttons to select a function from the list, and then press **P** to confirm.  
*This specifies the operation to be executed when the User 3 input pin at the rear of the meter is connected to the common pin (Section 5.6).*

USER PROGRAMMABLE INPUT FUNCTIONS:	
<b>NONE</b>	No action.
<b>TOT=0</b>	Reset totaliser to zero.
<b>TOT=LV</b>	Reset totaliser to totaliser load value.
<b>BCH=0</b>	Reset batch value to zero.
<b>BCH=LV</b>	Reset batch value to batching load value.
<b>T&amp;B=0</b>	Reset totaliser and batch values to zero.
<b>T&amp;B=LV</b>	Reset totaliser and batch values to their respective load values.
<b>BCNT=0</b>	Reset batch count to zero.
<b>HALT B</b>	Halt the current batch in progress (not available on User Input 2).
<b>HOLD</b>	Hold all counts (available on User Input 2 only). In this mode, activating User Input 2 will stop the batch process (turn the batching relay off), and will hold the current total and batch values until the pin is deactivated. Any pulses on the input will be ignored while the User Input 2 pin is activated. Deactivating User Input 2 will restart the batching process (turn the batching relay on again), and the total and batch values will continue counting from the previously held values.
<b>CONT B</b>	Continue with the current batch (not available on User Input 2).
<b>HOLD B</b>	Hold the batch count (available on User Input 2 only). In this mode, activating User Input 2 will stop the batch process (turn the batching relay off), and will hold the current batch value until the pin is deactivated. While User Input 2 is activated, the total value will continue to count input pulses, but the batch value will be held. Deactivating User Input 2 will restart the batching process (turn the batching relay on again), and the batch value will continue counting from its previously held value.
<b>UNLTCH*</b>	Unlatch all set-points.
<b>UNLT B*</b>	Unlatch BCH SP.
<b>UNLT (X)*</b>	Unlatch SP X (2-5).

\* When a set-point is configured for latching mode it will activate as normal and remain activated until it is unlatched either by set-point logic or manually (as specified in this section).  
 Refer to section 7.2H to configure set-point latching.

### 6.7 – Analogue output setup (when fitted):

- A** **\_\_\_ ANALOG OUTPUT SETUP** scrolls across the bottom row and **SKIP** appears in the top row.  
 Press **P** to skip to 6.8, or the **▲** button and then **P** to **ENTER** analogue output setup.
- B** **\_\_\_ DATA SOURCE FOR ANALOG OUTPUT** scrolls across the bottom row and the current selection appears in the top row. Use the **▲** and **▼** buttons to select: **NONE**, **RATE**, **TOTAL**, **BATCH** or **BCHCNT**. Then press **P**.  
*See Appendix A.i for more information on batching functions.*
- C** **\_\_\_ LOW SCALE VALUE FOR ANALOG OUTPUT** scrolls across the bottom row and the current selection appears in the top row. Use the **▲** and **▼** buttons to enter your cal low position, and then press **P**.  
*This sets the display value for cal low (as at 6.7F).*
- D** **\_\_\_ HIGH SCALE VALUE FOR ANALOG OUTPUT** scrolls across the bottom row and the current selection appears in the top row. Use the **▲** and **▼** buttons to enter your cal high position, and then press **P**.  
*This sets the display value for cal high (as at 6.7F).*
- E** **\_\_\_ CALIBRATE ANALOG OUTPUT?** scrolls across the bottom row and **SKIP** appears in the top row.  
 If you do not wish to calibrate your analogue output, press **P** now.  
**If you would like to calibrate your analogue output:**  
 Set the analogue output board jumper in the correct position (see Section 4) and connect a mA or volt meter across the analogue output connector (see 5.3).  
 Press the **▲** button to select **ENTER** and then **P** to enter calibration mode.

#### If you selected SKIP in 6.7E:

- F** Skip the rest of this section and continue to 6.8.

**If you selected ENTER in 6.7E:**

- F** \_\_\_ **CAL LOW ANALOG OUTPUT** scrolls across the bottom row and a calibration number appears in the top row. Using the **▲** and **▼** buttons, calibrate your low analogue output as required. Then press **P**.  
*The display value is shown in internal units (mA).*
- \_\_\_ **CAL HIGH ANALOG OUTPUT** scrolls across the bottom row and a calibration number appears in the top row. Using the **▲** and **▼** buttons, calibrate your high analogue output as required. Then press **P**.  
*The display value is shown in internal units (mA).*

**6.8 – Serial setup (when fitted):**

- A** \_\_\_ **SERIAL SETUP** scrolls across the bottom row and **SKIP** appears in the top row.  
Press **P** to skip to 6.9, or the **▲** button and then **P** to **ENTER** serial port setup.
- B** \_\_\_ **SERIAL MODE** scrolls across the bottom row and the currently selected serial mode appears in the top row. Using the **▲** and **▼** buttons, select: **ASCII**, **MODBUS** (RTU) or **RNGR A** (Ranger A). Then press **P**.

*ASCII is a simple protocol that allows connection to various PC configuration tools. MODBUS is an industry standard RTU slave mode that allows connection to a wide range of devices, such as PC's or PLC's. RNGR A is a continuous output, used to drive remote displays and other instruments in the Rinstrum™ range. (Ranger is a trade name belonging to Rinstrum Pty Ltd.)*

**If you selected ASCII or MODBUS in 6.8B:**

- C** Skip this step and continue to 6.8D now.

**If you selected RNGR A in 6.8B:**

- C** \_\_\_ **SERIAL DATA SOURCE** scrolls across the bottom row and the current Ranger A data source appears in the top row.  
Use the **▲** and **▼** buttons to select: **RATE**, **TOTAL**, **BATCH** or **BCHCNT**. Then press **P**.  
*See Appendix A.i for more information on batching functions.*
- D** \_\_\_ **BAUD RATE** scrolls across the bottom row and the current rate appears in the top row.  
Use the **▲** and **▼** buttons to select: **1200**, **2400**, **4800**, **9600**, **19200**, **38400**, **57600** or **115200**. Then press **P**.
- E** \_\_\_ **PARITY** scrolls across the bottom row and the current parity appears in the top row.  
Use the **▲** and **▼** buttons to select: **NONE**, **ODD** or **EVEN**. Then press **P**.
- F** \_\_\_ **SERIAL ADDRESS** scrolls across the bottom row and the current selection appears in the top row.  
Use the **▲** and **▼** buttons to set the serial address, and then press **P**.

*The serial address parameter is used to identify a particular device when it is used with other devices in a system. (It applies particularly to Modbus mode when used on a RS485 network.) The serial address of the controller must be set to match the serial address defined in the master device.*

**RANGER A** - This allows the controller to drive a remote display from the Rinstrum range. The following shows the output string format when Ranger A output is selected: **<Start> <Sign> <Output Value> <Status> <End>**

**STRING CHARACTER(S)**

- <Start>** STX character (ASCII 02).
- <Sign>** Output value sign (space for + and dash for -).
- <Output Value>** Seven character ASCII string containing the current output value and decimal point. (If there is no decimal point, then the first character is a space. Leading zero blanking applies.)
- <Status>** Single character output value status: U=Under, O=Over, E=Error.
- <End>** ETX character (ASCII 03).

**MODBUS REGISTERS** - These are all holding registers and should be accessed via function codes 3 and 6. Register addresses are displayed in the Modicon™ addressing format. i.e. Register 65=40065 (subtract 1 for direct addressing).

8-BIT UNSIGNED	
48207	Baudrate
48211	Serial address
48215	Serial mode

24-BIT SIGNED (2x16-bit)	
42509	Load value (Total)
42511	Load value (Batch)

16-BIT UNSIGNED	
44181	BCH SP (SP 1) hysteresis
44197	BCH SP (SP 1) make delay
44213	BCH SP (SP 1) break delay
44182	SP 2 hysteresis
44198	SP 2 make delay
44214	SP 2 break delay
44183	SP 3 hysteresis
44199	SP 3 make delay
44215	SP 3 break delay
44184	SP 4 hysteresis
44200	SP 4 make delay
44216	SP 4 break delay
44185	SP 5 hysteresis
44201	SP 5 make delay
44217	SP 5 break delay
45173	Batch count increment

32-BIT SIGNED (2x16-bit)	
40009	Rate
40011	Total
40013	Batch result
40015	Batch count
40081	Batch tare
40057	Peak
40059	Valley
40111	Batch set-point (SP 1)
40113	Set-point 2
40115	Set-point 3
40117	Set-point 4
40119	Set-point 5
40239	Alarm status

### 6.9 – Edit calibration PIN:

- A** **EDIT CAL PIN NUMBER?** scrolls across the bottom row and **SKIP** appears in the top row. Press **[P]** to skip and return to the operational display, or the **[▲]** button and then **[P]** to **ENTER**.
- B** **ENTER NEW CAL PIN NUMBER** scrolls across the bottom row and the current PIN (default = 1) appears in the top row. Using the **[▲]** and **[▼]** buttons, enter your new calibration PIN number. Then press **[P]** to exit and return to the operational display.

## SECTION 7. – Set-point Setup.

Enter the set-point setup mode by pressing and holding the **[F2]** button for 3 seconds.

### Note:

To SKIP or ENTER values - Push



To SELECT a menu input - Push



### 7.1 – Enter set-point PIN:

- A** **ENTER SP PIN NUMBER** scrolls across the bottom row and **0** appears in the top row. Use the **[▲]** and **[▼]** buttons to enter your security code (factory default 1). Then press **[P]**. If the correct PIN is entered then the setup is started at 7.2. If an incorrect PIN number is entered, **INCORRECT PIN NUMBER - ACCESS DENIED** scrolls across the display and it returns to the normal operating mode.

**You will be given the opportunity to change your PIN number at the end of this section (7.3). If you have forgotten your PIN number, see Section 10.**

### 7.2 – Edit set-points:

- A** **EDIT SETPOINT** scrolls across the bottom row and **SKIP** appears in the top row. Press **[P]** to skip to 7.3 or use the **[▲]** and **[▼]** buttons to select a set-point to edit: **BCH SP** (batch set-point / SP 1), **SP 2**, **SP 3**, **SP 4** or **SP 5**. Then press **[P]**.
- B** **SP VALUE** scrolls across the bottom row and the last set-point value entered appears in the top row. Using the **[▲]** and **[▼]** buttons, adjust the display value at which the set-point will activate. Then press **[P]**.

**If you selected BCH SP in 7.2A:**

Skip all intervening steps and continue to 7.2D now.

- C** **TRACK BATCH SP** scrolls across the bottom row and the last tracking setting appears in the top row. Using the **▲** and **▼** buttons, select **OFF** or **ON**. Then press **P**.  
*Setting this option to ON will cause the selected set-point to track the set-point value of the batch set-point. The value of the tracking set-point will then become an offset value, which is effectively added to the value of the batch set-point.*

**If you selected ON in 7.2C:**

Skip all intervening steps and continue to 7.2G now.

- D** **SETPOINT SOURCE** scrolls across the bottom row and the current set-point activation source appears in the top row. Use the **▲** and **▼** buttons to select: **RATE**, **TOTAL**, **BATCH** or **BCHCNT** (batch count). Then press **P**.

**If you selected RATE, BATCH or BCHCNT in 7.2D:**

Skip all intervening steps and continue to 7.2G now.

- E** **VOLUMETRIC PULSE** scrolls across and the current selection appears in the top row. Use the **▲** and **▼** buttons to select **OFF** or **ON**. Then press **P**.  
*When the selected set-point is activated in volumetric pulse mode, the totaliser will reset to 0 and then resume totalising. The selected relay will activate for the time specified below. See Appendix A.ii for more information on volumetric pulse.*

**If you selected OFF in 7.2E:**

Skip all intervening steps and continue to 7.2G now.

- F** **PULSE TIME** scrolls across the bottom row and current selection appears in the top row. Use the **▲** and **▼** buttons to select your pulse time (from 0.1 to 10.0 seconds), and then press **P**.  
*Pulse reset requires a minimum of 0.1 seconds. A combination of high input rates and low set-point values may exceed this limitation, resulting in missed output pulses.*

**If you selected ON in 7.2F:**

Skip all intervening steps and continue to 7.2U now.

- G** **SP ACTIVATION** scrolls across the bottom row and the last selected set-point activation appears in the top row. Using the **▲** and **▼** buttons, select the relay activation to operate **ABOVE** or **BELOW** the set-point value, and then press **P**.  
*Select ABOVE for the relay to turn on above the set-point value and off below it. Select BELOW for the relay to turn on below the set-point value and off above it.*

- H** **SETPOINT TYPE** scrolls across the bottom row and the last selected set-point type appears in the top row. Using the **▲** and **▼** buttons, select: **NORMAL**, **TIMED** or **LATCHD** (latched), and then press **P**.

**If you selected TIMED or LATCHD in 7.2H:**

Skip all intervening steps and continue to 7.2K now.

- I** **HYSTERESIS TYPE** scrolls across the bottom row and the current selection appears in the top row. Using the **▲** and **▼** buttons, select either **ALARM** or **CNTRL** (control). Then press **P**.

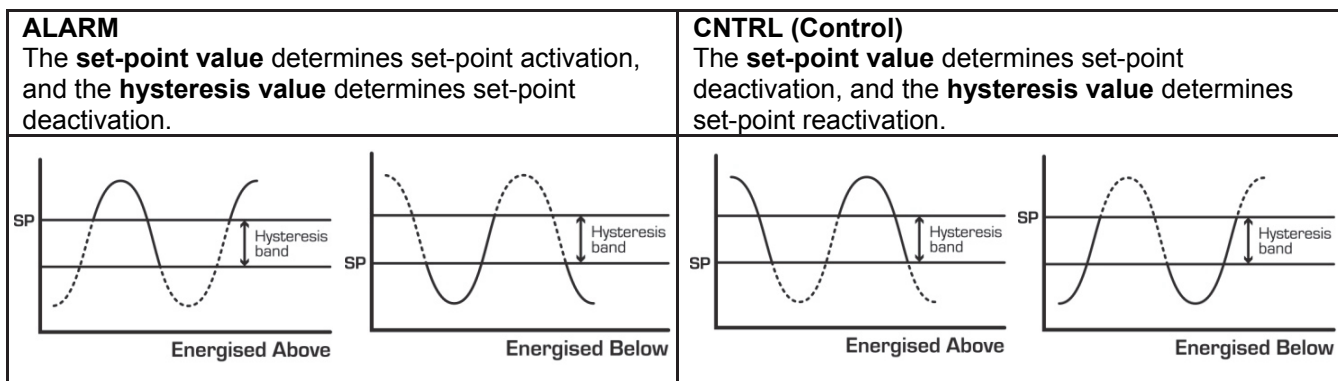

- J** **HYSTERESIS VALUE** scrolls across the bottom row and the current selection appears in the top row. Adjust this value using the **▲** and **▼** buttons, and then press **P**.  
*The hysteresis value defines the separation band between set-point activation and deactivation. Hysteresis will operate as per the specified type setting (see above).*

- K** \_\_\_ **MAKE DELAY** scrolls across the bottom row and the current selection appears in the top row. Adjust using the **▲** and **▼** buttons, and then press **P**.  
*This defines the delay between set-point activation and when the relay turns on.  
 This value is in tenths of a second.*

**If you selected TIMED or LATCHD in 7.2K:**

Skip step 7.2L.

- L** \_\_\_ **BREAK DELAY** scrolls across the bottom row and the current selection appears in the top row. Adjust using the **▲** and **▼** buttons, and then press **P**.  
*This defines the delay between set-point de-activation and when the relay turns off.  
 This value is in tenths of a second.*

**If you selected NORMAL or LATCHD in 7.2L:**

Skip step 7.2M.

- M** \_\_\_ **ON TIME** scrolls across the bottom row and the current value appears in the top row. Edit this value using the **▲** and **▼** buttons. Then press **P**.  
*This value is displayed in seconds with a 0.1 second resolution and is the time the relay remains energised.*

- N** \_\_\_ **STARTUP INHIBIT** scrolls across the bottom row and the current selection appears in the top row. Use the **▲** and **▼** buttons to select **NO** or **YES**. Then press **P**.

*This option can be used with set-points which may be active initially at power up. Setting this option to YES will cause a relay to remain off (de-energised) at power up until it has first reached its inactive state. It will then function normally.*

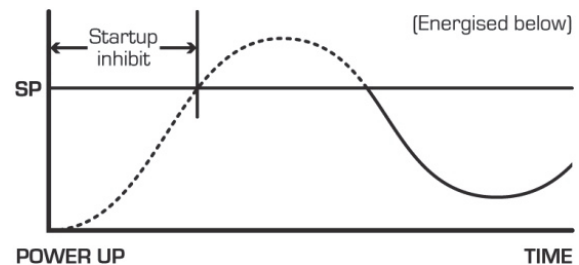

- O** \_\_\_ **RESET ACTION** scrolls across the bottom row and the current selection appears in the top row. Use the **▲** and **▼** buttons to choose: **NONE**, **RS TOT** (reset total), **RS BAT** (reset batch), **RS BCT** (reset batch count) or **UNLTCH** (unlatch set-points). Then press **P**.

**If you selected RS BAT, UNLTCH or NONE in 7.2O:**

Skip step 7.2P.

**If you selected NONE in 7.2O and SP 2-5 in 7.2A:**

Skip all intervening steps and continue to 7.2U now.

*See Appendix A.i for more information on batching functions.*

- P** \_\_\_ **RESET VALUE** scrolls across the bottom row and the current reset value appears in the top row. Edit using the **▲** and **▼** buttons and press **P**.  
*The reset value is the value which will be loaded into the destination register selected by **RESET ACTION** (7.2O) when the selected **RESET EDGE** (7.2Q) occurs.*

- Q** \_\_\_ **RESET EDGE** scrolls across the bottom row and the current setting appears in the top row. Using the **▲** and **▼** buttons, choose: **NONE**, **MAKE** (make edge - relay energises), **BREAK** (break edge - relay de-energises) or **BOTH** (make and break edges). Then press **P**.

**If you selected SP 2-5 in 7.2A:**

Skip all intervening steps and continue to 7.2U now.

- R** \_\_\_ **BATCH COUNT MODIFIER** scrolls across the bottom row and the current value appears in the top row. Use the **▲** and **▼** buttons to adjust this value if desired, and then press **P**.  
*A **positive** number will cause the batch count register to be incremented by that amount each time the selected reset edge is triggered. Likewise, a **negative** number will cause the batch count register to be decremented. Setting this value to **zero** will effectively disable this feature. See Appendix A.i for more information on batching functions.*

- S** \_\_\_ **INFLIGHT CORRECTION** scrolls across the bottom row and the current option appears in the top row. This function is used to correct for overrun errors caused by pipes/valves etc. Use the **▲** and **▼** buttons to turn this feature **ON** or **OFF**, and then press **P**.  
*When inflight correction is turned on, the batch error (difference between batch set-point value and the final batch value) is averaged over the last 3 batches. When a batch has finished, the controller waits for the Inflight Adjustment Delay time and then calculates a new inflight correction offset for the next batch.*

During the next batch, the effective BCH SP value is modified to include the calculated Correction Offset value, in an attempt to compensate for errors. (Correction Offset cannot be greater than 50% of the set-point value).

**If you selected OFF in 7.2S:**

Skip step 7.2T.

**T** **\_\_\_ INFLIGHT ADJUSTMENT DELAY IN SECONDS** scrolls across the bottom row and the current value appears in the top row. This function is used to specify the time delay between the batching relay turning off and the inflight correction calculation being made.

Use the **▲** and **▼** buttons to adjust the inflight delay time and then press **P**.

**U** **\_\_\_ USER ACCESS?** scrolls across the bottom row and the last selected direct access setting appears in the top row. Using the **▲** and **▼** buttons, select either **OFF** or **ON**. Then press **P**.

When enabled, this allows the set-point value to be edited directly after pressing the F2 button. See Section 8.

**V** **\_\_\_ EDIT SETPOINT** scrolls across the bottom row and **SKIP** appears in the top row.

To edit another set-point, follow the instructions from 7.2A-U. If you do not wish to edit another set-point, press **P** now to proceed to 7.3.

### 7.3 – Edit set-point PIN:

**A** **\_\_\_ EDIT SP PIN NUMBER** scrolls across the bottom row and **SKIP** appears in the top row.

Press **P** to skip and return to the operational display, or the **▲** button and then **P** to **ENTER**.

**B** **\_\_\_ ENTER NEW SP PIN NUMBER** scrolls across the bottom row and the current PIN (default = 1) appears in the top row. Using the **▲** and **▼** buttons, enter your new set-point entry PIN number.

Then press **P** to **EXIT** and return to the operational display.

## SECTION 8. – Set-point Direct Access.

If none of the set-points have their direct access option enabled then the **F2** button will not respond to a short button press. (See 7.2U to enable.)

### 8.1 – Set-point direct access

**A** Begin by pressing the **F2** button for less than 3 seconds. The set-point name (**BCH SP**, **SP 2**, **SP 3**, **SP 4** or **SP 5**) will appear in the bottom row and the current set-point value will appear in the top row.

Using the **▲** and **▼** buttons, adjust the selected value. Then press **P** to accept the new set-point value.

**B** If any other set-points have the direct access option enabled then the same process is repeated for the next set-point. Pressing **P** for the last enabled set-point will exit and return to the operational display.

## SECTION 9. – Display Shortcuts.

Use these shortcuts for quick viewing of specified parameters from the operational display.

### 9.1 – View

**A** Begin by pressing the **▲** button for half a second. **RATE** will appear in the bottom row, and the current rate value will appear in the top row.

**B** Use the **▲** and **▼** buttons to view the values shown below. Press **P** to return to the operational display.

<b>▲</b>	<b>▼</b>
<b>RATE</b>	<b>TOTAL</b>
<b>BATCH</b>	<b>BT CNT</b> (batch count)
<b>PEAK</b> (rate)	<b>INFLIT</b> (in-flight correction)
	<b>VALLEY</b> (rate)

### 9.2 – Reset

**A** To reset either **PEAK** or **VALLEY**, press both the **▲** and **▼** buttons together while the required parameter is being displayed (as in 9.1). Press **P** to return to the operational display.

## SECTION 10. – Reset PIN Numbers.

If you have forgotten either of your PIN numbers, follow the procedure below to reset both the calibration and setpoint entry PIN's to their factory default of 1.

### 10.1 – Reset PIN numbers:

- A Press the **▲**, **▼** and **P** buttons at the same time.  
(This key combination can be difficult to execute and you may need several tries to get it right.)
- B When successful, a factory identification text will scroll across the display, followed by:  
**\_\_\_ ALL PIN NUMBERS RESET TO 1.**
- C Reset the calibration PIN numbers if required by following the instructions in Sections 6.9 and 7.3.

## SECTION 11. – Display Brightness.

Follow the instructions below to adjust the brightness of your LED display.

### 11.1 – Adjust display brightness:

- A Press the **P** and **▲** buttons together from the operational display. **BRI** appears in the bottom row and the current brightness setting appears in the top row.
- B Use the **▲** and **▼** buttons to adjust the brightness of the LED backlight as required, and then press **P**.  
The display returns to normal operating mode.

## Appendix A – Register functions.

### A.i – Batching:

This function allows the Total count to be maintained, as well as the current batch value.

$$\text{Batch} = \text{Total} - \text{Batch Tare}$$

**Batch Tare** is reset to the **Total** value when the **RST BT** (reset batch) function is triggered. **RST BT** can be activated via set-point logic (7.2O), or via the **P** button or rear pins (see 6.6).

**Batch Count** allows the user to count how many completed batches have been processed. The **Batch Count Modifier** (7.2R) value is added to the **Batch Count** register each time **BCH SP** activates, as per the selected reset edge (7.2Q).

### A.ii – Volumetric pulse:

This function outputs a pulse on a relay when **Total**  $\geq$  **Set-point Value**. It also resets the value of **Total** as calculated below:

$$\text{Total} = \text{Total} - \text{Set-point Value}$$

This function is useful for feeding volume information to other equipment. The length of the pulse can be adjusted in 0.1 second increments (7.2F) to suit the requirements of externally connected devices.

**Intech**  
Instruments

[www.intech.co.nz](http://www.intech.co.nz)

Christchurch Ph: +64 3 343 0646  
Auckland Ph: 09 827 1930  
Email: [sales@intech.co.nz](mailto:sales@intech.co.nz)